

# Eaton® Clutches CLTS1271

September 2011



*Powering Business Worldwide*

BACKED BY

**Roadranger**

SUPPORT



# Introduction

## Clutch Diagrams

### Easy-Pedal Heavy Duty Clutch

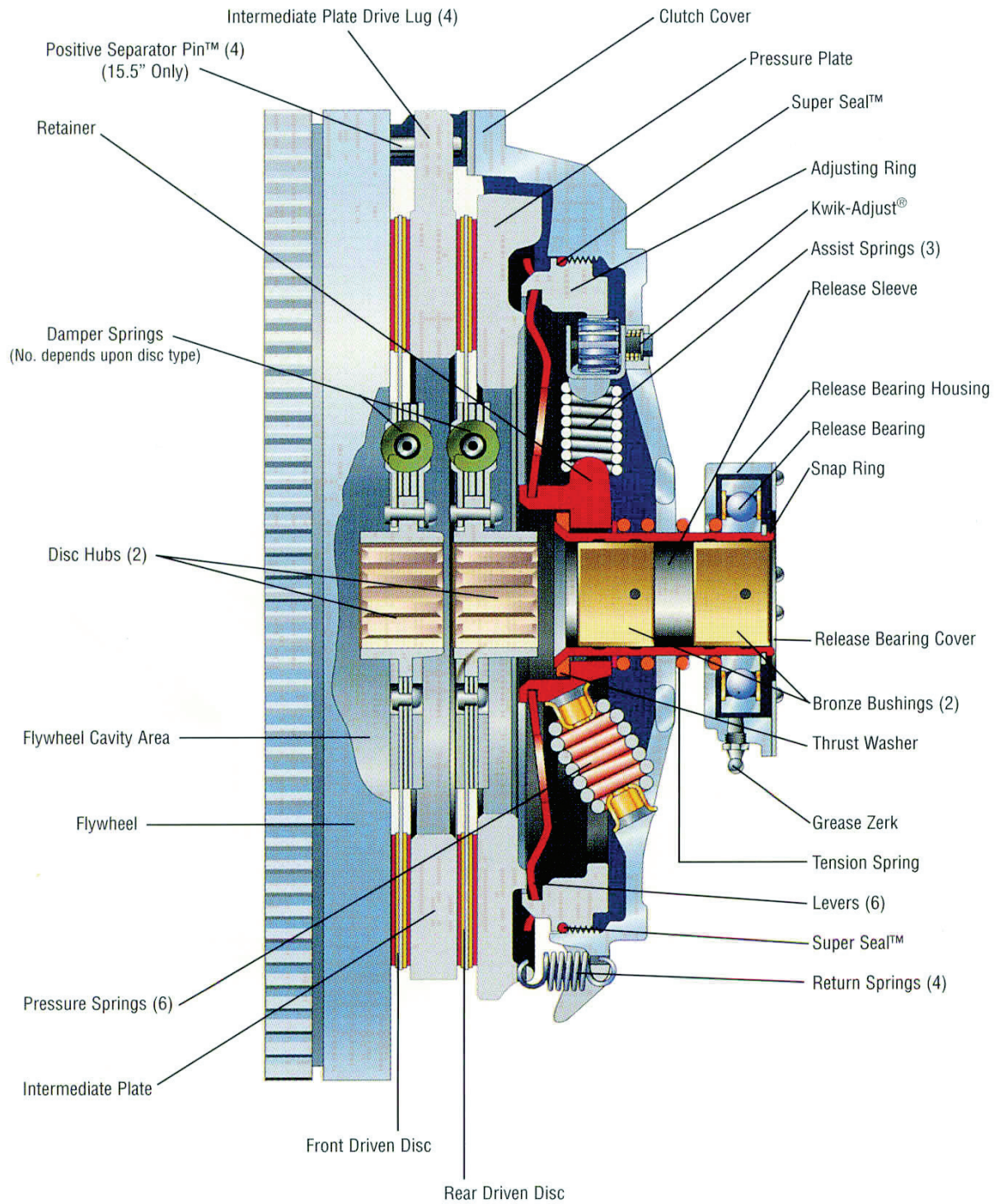

# Solo Adjustment-Free Heavy Duty Clutch

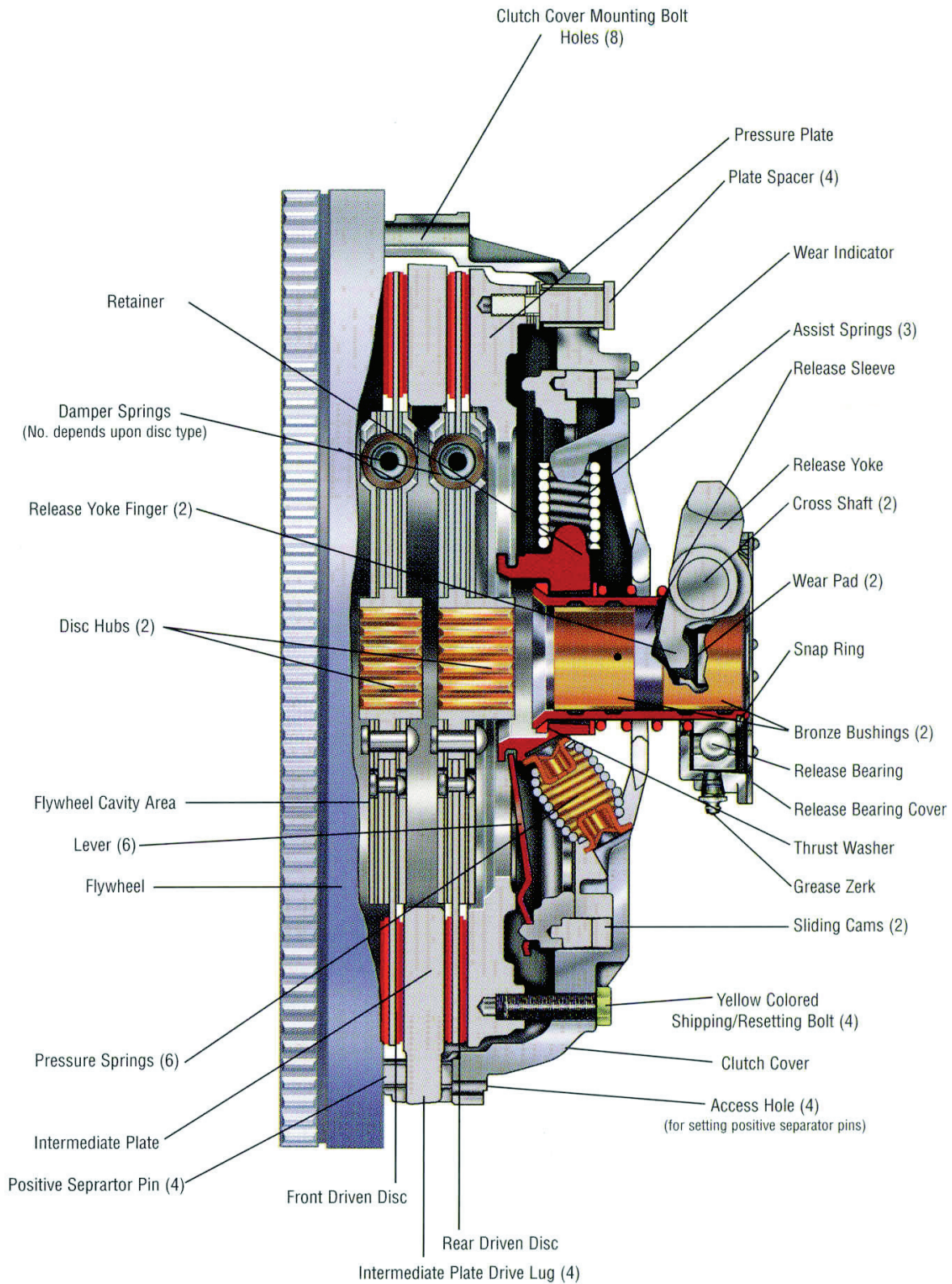

# Table of Contents

---

## Introduction

Clutch Diagrams.....	1
Factors that Effect Clutch Performance .....	1

## Glossary

Clutch Glossary .....	39
-----------------------	----

## Clutch Cover/Intermediate Plate

Clutch Cover/Intermediate Plate Failures.....	3
---	---

## Clutch Disc Assembly

Clutch Disc Assembly Failures .....	15
-------------------------------------	----

## Adjusting Mechanisms and Clutch Brakes

Adjusting Mechanism and Clutch Brake Failures.....	24
--	----

## Solo Clutch

Solo Clutch Failures .....	25
----------------------------	----

## Miscellaneous

Miscellaneous Failures .....	27
------------------------------	----

## Pilot Bearing

Pilot Bearing Recommendations .....	30
-------------------------------------	----

## Troubleshooting

Clutch Troubleshooting .....	31
------------------------------	----



## Factors that Effect Clutch Performance

The major cause of clutch failure can be summarized with two words: "EXCESSIVE HEAT". Extreme operating temperatures (excessive heat) can cause the clutch to fail because the heat generated between the flywheel, driven discs, intermediate plate, and pressure plate are high enough to cause the metal to flow and the friction material to be destroyed.

Heat or wear is practically nonexistent when a clutch is fully engaged. But, during the moment of engagement (when the clutch is picking up the load), it generates considerable heat. An improperly adjusted or slipping clutch will generate sufficient heat to rapidly self-destruct.

Proper training of drivers and mechanics can go a long way toward extending clutch life. Anyone who drives the truck, whether on or off highway, should learn how to operate the vehicle properly. The most critical points to cover in driver training programs are: learning to start in the right gear, proper clutch engagement, recognizing clutch malfunctions, and recognizing the need for readjustment.

Maintenance personnel may want to attend driver training programs to see what driver misuse can do to clutch life. This training will place them in a better position to spot and analyze failures during their clutch maintenance programs.

The most important areas to cover in the training programs that can affect clutch performance are:

### **STARTING THE VEHICLE IN THE PROPER GEAR**

An empty truck can be started satisfactorily in a higher transmission gear ratio than when partially or fully loaded. If auxiliary transmissions or multi-speed axles are used, they must be in the lower ratios for satisfactory starts. Drivers should be shown what ratios can be used for safe starts when the truck is empty or loaded. If the truck is diesel powered, a good rule of thumb for the driver to follow is: empty or loaded, select the gear combination that lets you take up the slack and start moving out with an idling engine or, if necessary, just enough throttle to prevent stalling the engine. After the clutch is fully engaged, the engine should be accelerated for the upshift into the next higher gear.

### **GEAR SHIFTING TECHNIQUES**

Many drivers upshift into the next gear-or even skip-shift into a higher gear-before the vehicle has reached the proper speed. This type of shifting is almost as damaging as starting off in a gear that is too high, since the engine speed and vehicle speeds are too far apart, requiring the clutch to absorb the speed difference as heat (excessive slippage).

### **EXCESSIVE VEHICLE OVERLOAD OR OVERLOADING THE CLUTCH**

Clutches are designed and recommended for specific vehicle applications and loads. These limitations should not be exceeded. Excessive or extreme overloading can not only damage the clutch, but the entire vehicle power train as well. If the total gear reduction in the power train is not sufficient to handle excessive overloads, the clutch will suffer, since it is forced to pick up the load at a higher speed differential.

### **RIDING THE CLUTCH PEDAL**

This practice is very destructive to the clutch since a partial clutch engagement permits slippage and excessive heat. Riding the clutch pedal will also put a constant thrust load on the release bearing, which can thin out the lubricant and also cause excessive wear on the pads. Release bearing failures can be attributed to this type of operation.

### **HOLDING THE VEHICLE ON AN INCLINE WITH A SLIPPING CLUTCH**

This procedure uses the clutch to do the job normally expected of the wheel brakes. A slipping clutch accumulates heat faster than it can be dissipated, resulting in early failures.

### **COASTING WITH THE CLUTCH RELEASED AND TRANSMISSION IN GEAR**

This procedure can cause high driven disc R.P.M. through multiplication of ratios from the final drive and transmission. It can result in "throwing" the facing off the clutch discs. Driven disc speeds of over 10,000 R.P.M. have been encountered in such simple procedures as coasting tractors down an unloading ramp. While an ample safety factor is provided for normal operation, the burst strength of the facing is limited.

# Introduction

---

## **ENGAGING CLUTCH WHILE COASTING**

This procedure can result in tremendous shock loads and possible damage to the clutch, as well as the entire drivetrain.

## **REPORTING ERRATIC CLUTCH OPERATION PROMPTLY**

Drivers should report erratic clutch operation as soon as possible, to give the maintenance personnel a chance to make the necessary inspection, internal clutch adjustment, linkage adjustments, lubrication, etc., thereby avoiding possible clutch failures and breakdowns while on the road. The importance of free-pedal travel (sometimes referred to as pedal lash) should be brought to the driver's attention as well as the mechanic. This item should be included and commented on daily in the driver's report, since clutch free-pedal is the maintenance personnel's guide to the condition of the clutch and the release mechanism.

## **CLUTCH ADJUSTMENTS**

Drivers and mechanics should be made aware of the fact that Eaton Fuller Angle-Spring and Easy-Pedal Clutches have provisions for an internal clutch adjustment. This permits the clutch "itself" to be readjusted while it is in the vehicle. Details of the clutch adjustment are covered in the Eaton Fuller Installation Instructions packaged with each clutch assembly.

When drivers and mechanics are properly trained, there are still certain problems that may occur. The following failure analysis and troubleshooting guide lists some common problems, their causes, and suggested corrective action. Note that some of these problems relate back to the previous discussion on poor driving and maintenance techniques.



## Clutch Cover/Intermediate Plate Failures

### Failure - Yoke Bridge Rubbing into Cover

#### Possible Causes

The arrows in Figures 1 and 2 show the areas of contact between the release yoke bridge and the clutch cover. Overstroking of the yoke, in an attempt to obtain the required 1/2" - 1" clutch brake squeeze, is a typical cause of this failure.

The reason that normal clutch brake squeeze cannot be obtained may be due to one or more of the following situations:

- Worn clutch brake
- Broken or missing clutch brake
- Worn or incorrect transmission bearing retainer cap (refer to Figure 3)
- Excessive wear on release bearing wearing pads and/or the fingers of the yoke (refer to Figure 1)
- Improper set up of the linkage system. Consult your OEM service manual
- Incorrect yoke installed

**Note:** The clutch cover can be reused if the above items are corrected, a new yoke is installed, and there are no broken or cracked parts on the cover. The above failure is typically preceded by a noise complaint and/or vibrating clutch pedal at the point where the clutch pedal is fully depressed. Depending upon the amount of wear (at the bearing cap and/or yoke fingers/wear pads), it may be possible to adjust the linkage to eliminate the noise complaint.

#### TRANSMISSION BEARING RETAINER CAP

Dimension A, based on SAE standards, is 8.657" (219.9 mm) nominal, and should not be greater than 8.71" (221.5 mm) Ref. 1990 S.A.E. handbook 4:36.106

Fig 1

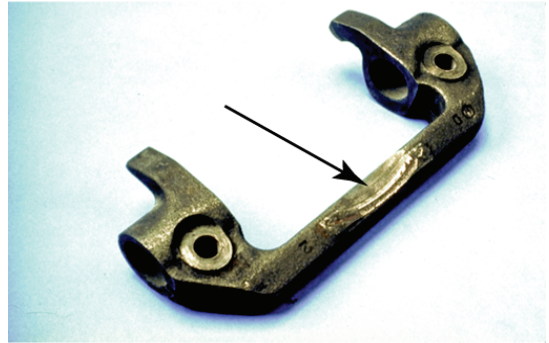

Fig 2

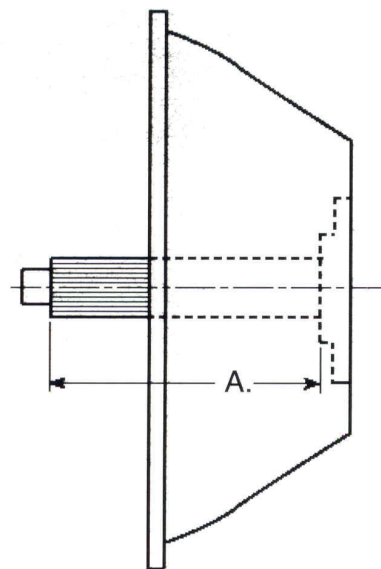
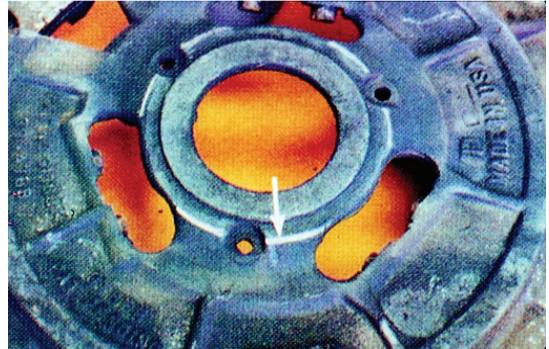

Figure 3

# Clutch Cover/Intermediate Plate

Fig 4

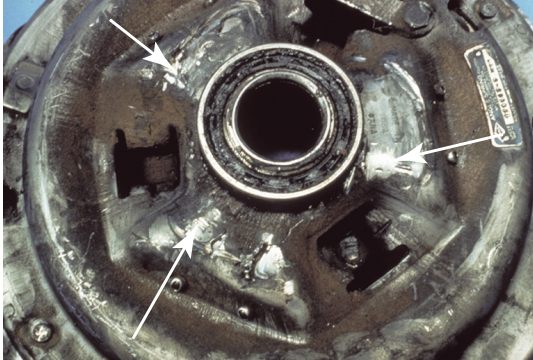

Fig 5

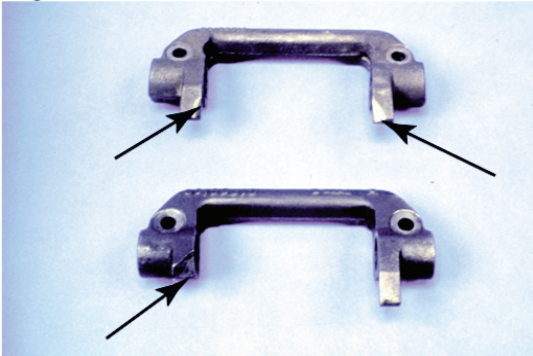

Fig 6

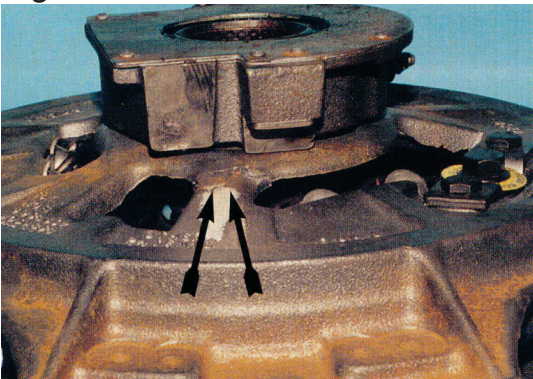
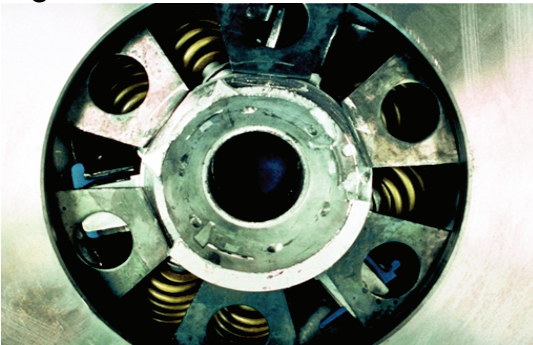

Fig 7



## Failure - Yoke Fingers Rubbing into Clutch Cover

### Possible Causes

Figures 4 - 5 show the damage that results when the release yoke contacts the clutch cover. More specifically, the fingers have become pinched between the clutch cover and release bearing, resulting in one or more of the following:

- A broken /cracked release bearing housing (not shown)
- Damage to the clutch cover (see arrows, Figure 4)
- Wear to the backside of the yoke fingers (see arrows in Figure 5, top yoke)
- Broken yoke finger(s) (see arrow in Figure 5 bottom yoke)

Some causes of the above failure are:

- Linkage system broke, allowing the loose yoke to contact cover
- Linkage system was improperly reinstalled (example: forgetting to reinstall the cotter key, allowing the clevis pin to come out)
- Adjusting the clutch with the linkage instead of internally using the adjusting ring
- Rotating the ring the wrong direction (counterclockwise instead of clockwise) when adjusting for clutch wear

**Note:** The above conditions may be preceded by a noise complaint.

## Failure - Cracked/Broken Clutch Cover

### Possible Causes

Referring to the arrow in Figure 6, this brand new clutch (Easy-Pedal 1402 S.D.) was damaged during transmission installation. More specifically, the release yoke "fingers" were elevated to the "straight out position" and were allowed to jam into the clutch cover. Subsequent damage might be a broken finger(s)(Figure 5) or bent release yoke / cross shafts. As a result, it is important that these parts be inspected for damage (and replaced if damaged) before installing a new clutch.

## Failure - Broken Retainer Assembly

### Possible Causes

Figure 7 shows what can happen when the levers break through the retainer's nose. The primary cause of this failure is allowing the transmission to hang unsupported in the driven disc during transmission installation.

## Failure - Clutch Cover Detached from Flywheel

### Possible Causes

The broken mounting bolts, show in Figure 8, are the direct result of insufficient torquing of these (8) bolts to the flywheel. More specifically, these bolts were loose enough to allow the clutch cover to hammer back and forth against each bolt until they broke. Also, the (8) mounting bolt holes in the clutch cover were “egg-shaped” as a result of the constant hammering.

Additional damage occurred to both the clutch cover and the release yoke as a result of their interference with each other (refer to the arrows in Figures 9 and 10). It is worth noting that this service clutch had accumulated 50,000+ miles before it failed.

Another potential cause of the above failure would be the over-torquing of the mounting bolts. Doing so can cause the bolts to fracture and eventually separate from the flywheel. Combining this scenario with low grade mounting bolts will increase the chances of failure.

**Note:** Refer to the Eaton Installation Instructions (packaged with each clutch) to determine the proper mounting bolt torque, minimum grade of bolt, etc., for the specific Eaton Fuller Clutch model you are installing.

Fig 8



Fig 9

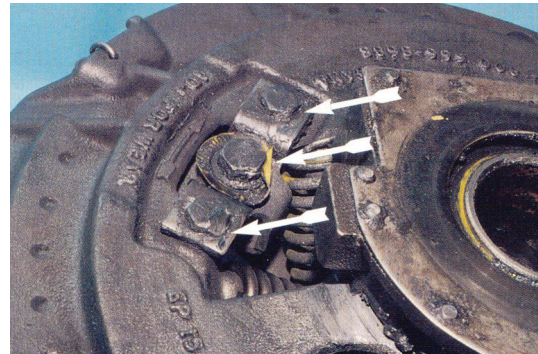
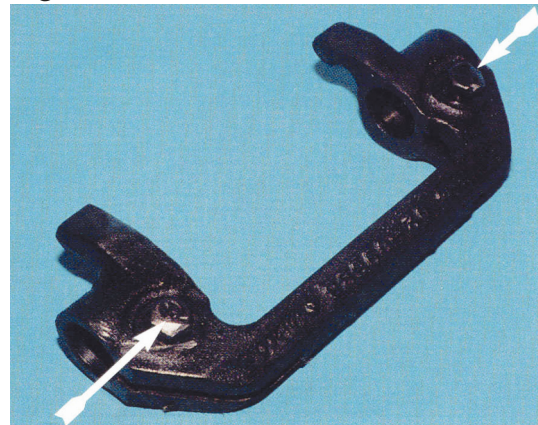

Fig 10



# Clutch Cover/Intermediate Plate

Fig 11

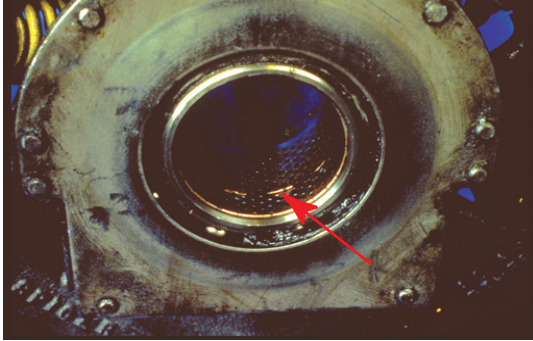

Fig 12

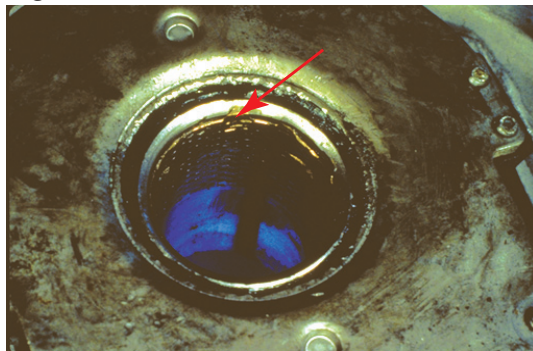
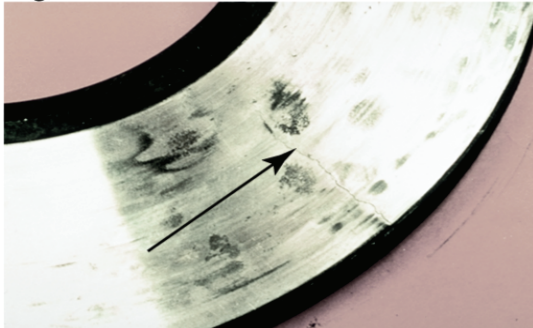

Fig 13



## Failure - Damaged Sleeve Bushing

### Possible Causes

Failure to center the input shaft with the sleeve of the release bearing assembly, when installing the transmission, can cause this failure. If the transmission hangs up during installation, investigate the cause before proceeding as excessive force can damage the bushing (see arrow in Figure 12). Allowing the transmission to hang unsupported in the sleeve bushing can damage the bushing. The arrow in Figure 11 shows another example of sleeve bushing damage on a heavy duty clutch.

## Failure - Damaged Intermediate or Pressure Plate

### Possible Causes

Figures 13 - 16 depict damaged clutch plates which resulted from an abnormal amount of clutch slippage/heat. Some causes of this abnormal slippage/excess heat can be one or more of the following:

1. Incorrect clutch applications. In other words, the engine's torque rating exceeds the clutch's torque rating.
- Driver abuse. (refer to Factors that Effect Clutch Performance Sections concerning the specific driver practices that can lead to excessive heat).
- Improper/ inadequate clutch adjustments. More specifically, operating the truck without free-play for extended periods of time; adjusting the clutch via the linkage instead of the required internal adjustment.
- Overloading of the vehicle.

Figure 13 is an example of a cracked pressure plate. The heat flow was so great that the metal could not dissipate it quickly enough.

## Failure - Damaged Intermediate of Pressure Plate (Continued)

### Possible Causes (Continued)

Figure 14 shows a broken intermediate plate. As in the previous example, the heat flow was so intense that the metal could not disperse the heat quickly enough.

In Figure 15, an area of the intermediate plate has been circled to reveal the damage of heat checks. These heat checks are actually small cracks with raised ridges that are capable of shaving off the facings of the driven disc.

Finally, Figure 16 reveals an example of a burned or scorched intermediate plate in which the metal became so hot that it began to flow. The typical evidence of such a failure will be one or more of the following:

- High and low spots on the plate
- Partial transfer of the facing material (ceramic or organic) from the driven disc onto the plate
- A blue discoloration throughout the failed part

To view the resulting damage that can occur to the facing material of the driven discs, please refer to Figures 53-56 and 58.

## Failure - Grooved Pressure Plate

### Possible Causes

The groove (see arrow in Figure 17) worn into the face of this pressure plate was caused by the rivets of the driven disc facing. (For the related disc failure, see the description under Figure 70). The same damage can occur on both the intermediate plate and flywheel. A surface that is grooved can damage the new driven discs that are installed. As a result, a new clutch assembly should be installed. Refer to the OEM service manual concerning flywheel resurfacing.

Fig 14

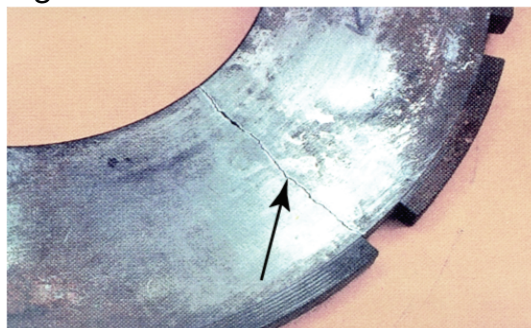

Fig 15

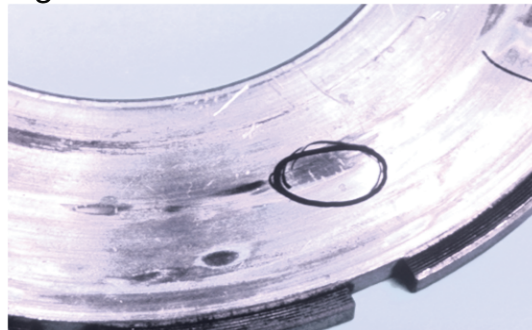

Fig 16

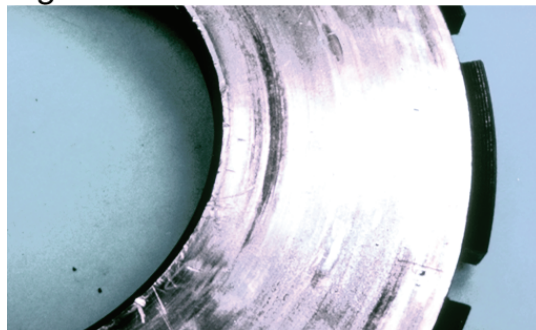
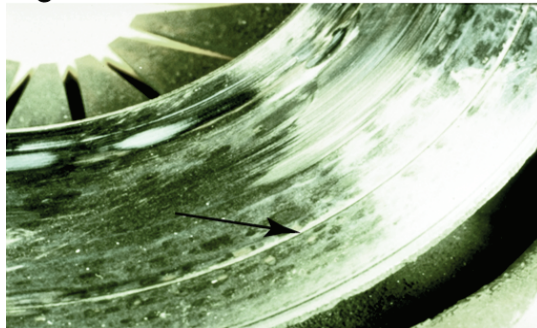

Fig 17



# Clutch Cover/Intermediate Plate

---

Fig 18



## Failure - Cocked Drive Pins (14" Pot-Style Clutches Only)

### Possible Causes

The groove worn in the face of the drive pin slots are on the upper section of the face on one side of the slot (see arrow in Figure 18) and on the lower section on the opposite side of the slot. This indicates that the drive pins were cocked and causing the intermediate plate to hang-up. This will cause release problems and therefore hard shifting. Do not file the slots of the intermediate plate to correct the problem. Instead, you must reset the drive pin(s) until they are square to the flywheel.

**Note:** Always install new Eaton drive pins when installing a new Eaton Fuller 14" Heavy Duty Clutch. This is important because worn drive pins (against the new intermediate plate slots) can prevent the clutch from releasing cleanly. Also, ensure that the drive pins are set squarely to the flywheel's friction surface (refer to the Eaton Installation Instructions packaged with each Eaton Fuller Clutch). Failure to set each drive pin squarely is the most prevalent reason for a "poor release complaint" on a recently installed clutch (Angle Spring and Easy-Pedal Plus 1402).

Fig 19

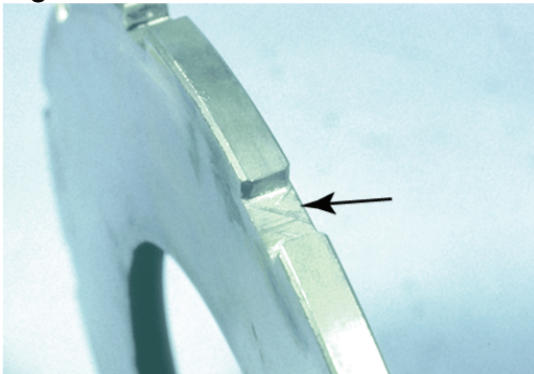

## Failure - Filed Drive Slots

### Possible Causes

As indicated by the shiny areas on the drive slots, (see arrow Figure 19) the slots of this intermediate plate were hand filed. Eaton does not recommend this practice since it can cause unequal loading on the drive pins in the flywheel. Instead, Eaton recommends that the drive pins be checked for squareness to the flywheel friction surface and reset if necessary (see Eaton Installation Instructions).

## Failure - Broken Drive Pins and Worn/Broken Drive Slots (14" Pot-Style Clutches Only)

### Possible Causes

Figure 20 shows a broken drive pin head that has become wedged into the intermediate plate's drive slot. Figure 21 is the same intermediate plate but with excessively worn and broken drive slots. Figure 22 shows a broken drive pin. The above failures can be caused by one or more of the following:

- Failure to use the anti-rattle springs packaged with each super-duty clutch
- Misapplication of the clutch
- Unequal loading on the drive pins as a result of filing the drive slots.

**Note:** Failure to use the anti-rattle springs can cause other problems such as a noisy or poor releasing clutch.

Fig 20

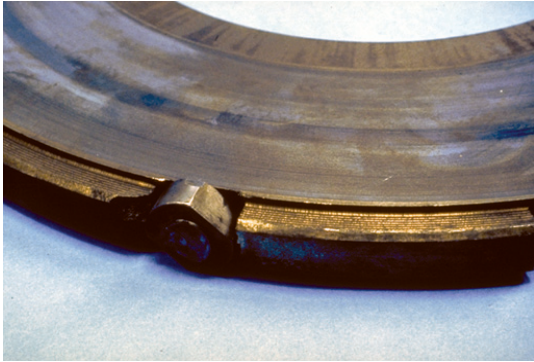

Fig 21

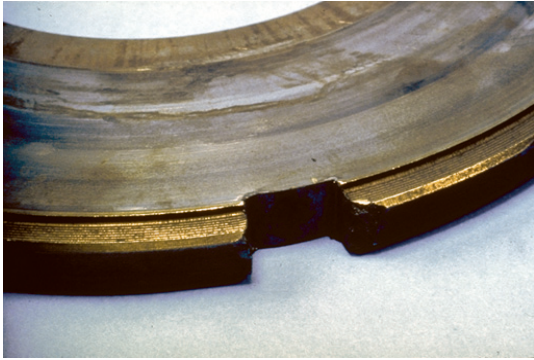
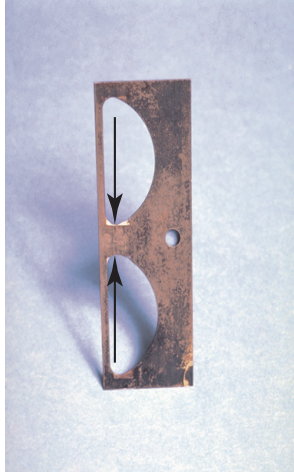

Fig 22



# Clutch Cover/Intermediate Plate

Fig 23



## Failure - Anti-Rattle Springs Installed Backwards

### Possible Causes

As shown in Figures 23 and 24, the intermediate plate was “hanging up” at the corners of the open sections of the anti-rattle springs. The driver’s complaint was a clutch that would not release. It is important that the rounded sections of the anti-rattle springs be installed TOWARDS the flywheel/ engine.

Fig 24

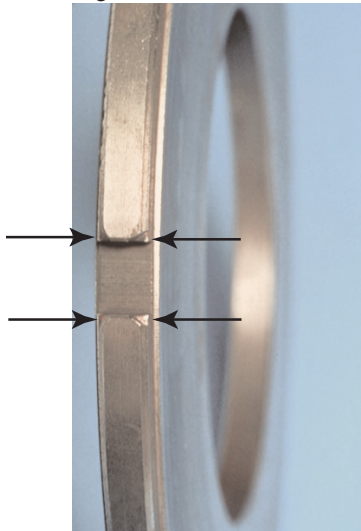

## Failure - Interference Between Retainer Assembly and Rear Disc Rivets

### Possible Causes

Figure 25 shows the damage done to the nose of the retainer assembly (see arrow) due to contact with the disc rivets. Figure 57 shows the resulting damage done to the rear disc. Adjusting the clutch externally (with the linkage) instead of internally (rotation of adjusting ring) will cause the retainer sleeve/release bearing assembly to move too far forward as the clutch wears, leading to this failure.

Fig 25

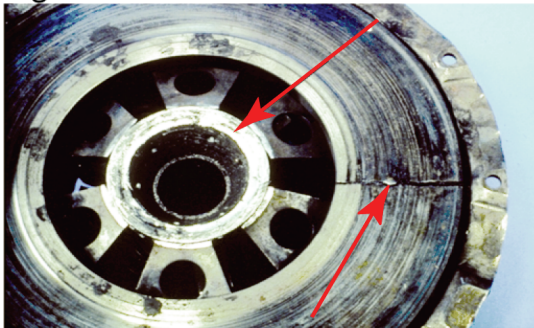

An additional result from the above failure is that while the clutch is engaged, it can begin to slip due to the unloading condition created by the disc and retainer interference. This, in turn, will create excessive heat and can cause the pressure plate to break (see Figure 25, black arrow on pressure plate) and /or the ceramic buttons to separate from the disc (see Figure 58). The above failure may also be preceded by a noise complaint.



## Failure - Broken Leg

### Possible Causes

- Abusing the clutch during shipping and handling.
- Dropping the clutch during installation or removal.

The photo in Figure 27 is a close-up of the broken leg shown in Figure 26. The arrow in this close-up shows where the leg contacted the concrete floor after the clutch was dropped.

The use of “guide studs” plus a “hydraulic clutch stand” will help prevent this 150 lb. clutch from being dropped during installation and removal.

**Note:** Eaton Clutch does not provide warranty coverage for this type of failure.

Fig 26

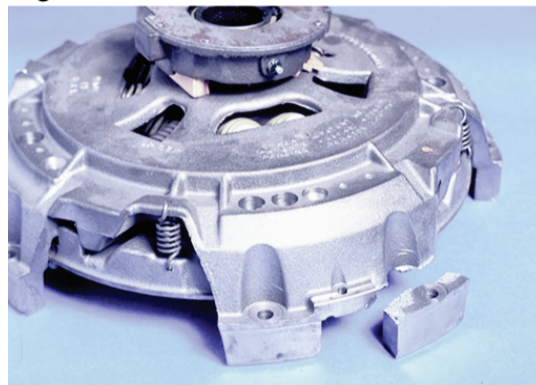
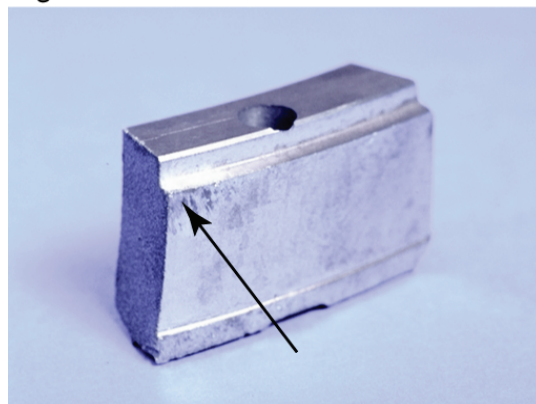

Fig 27



## Failure - Release Bearing

### Possible Causes

A failed release bearing (see Figure 28) can usually be attributed to one or more of the following situations:

- A dry release bearing due to lack of periodic lubrication (does not apply to sealed bearings).
- Failure to fully release or riding the clutch pedal will place a constant thrust load on the bearing, (see arrows in Figure 29) leading to higher temperatures and consequential loss of lubricant. Failure to maintain free play up in the cab can also cause this condition. Not only will the bearing begin to fail, constant contact in this area will cause both the release yoke fingers (Figure 79), and the wear pads (Figure 29), to wear excessively.
- A potential result of this wear is that the release yoke will force the bearing and sleeve assembly against the input shaft. Consequently, this “side loading” condition can damage the bushing, sleeve, and input shaft (see Figure 78).
- Failure to use the recommended high temperature lubricant can also cause a loss of lubricant, even under normal operating conditions. An impending release bearing failure may be accompanied by noise.

**Note:** In order to determine the proper greasing techniques, be sure to consult the Eaton Installation Instructions packaged with each Eaton Fuller Clutch.

Fig 28

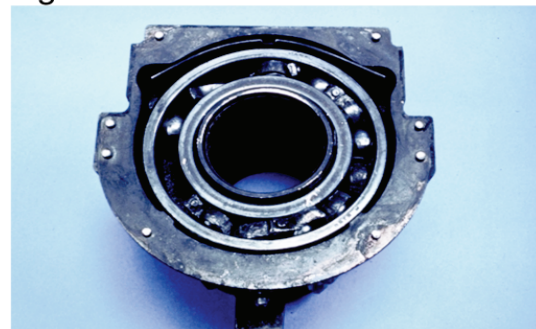

Fig 29



# Clutch Cover/Intermediate Plate

---

Fig 30

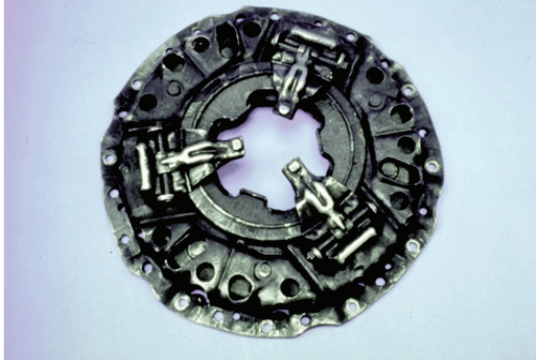

## Failure - Oil Soaked Cover

### Possible Causes

A leaking transmission or a leaky rear main engine seal can coat the clutch cover with oil, as indicated in Figure 30. Figure 41 shows the disc which was run with this cover.

Fig 31

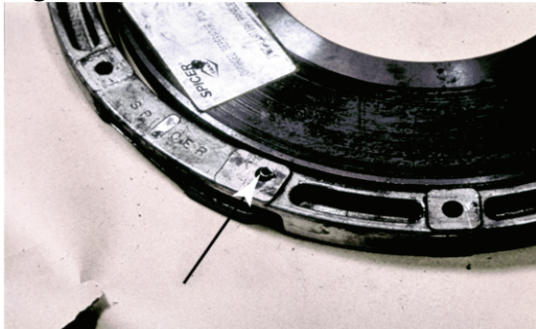

## Failure - Bent/Damaged Positive Separator Pin

### Possible Causes

The separator pin shown in Figure 31 became damaged (bent) when it was dropped during clutch installation. To prevent this from occurring, Eaton recommends the use of two (2) guide studs when mounting the intermediate plate and clutch cover to the flywheel (refer to the Eaton Installation Instructions).

Fig 32 (EPP 15.5")

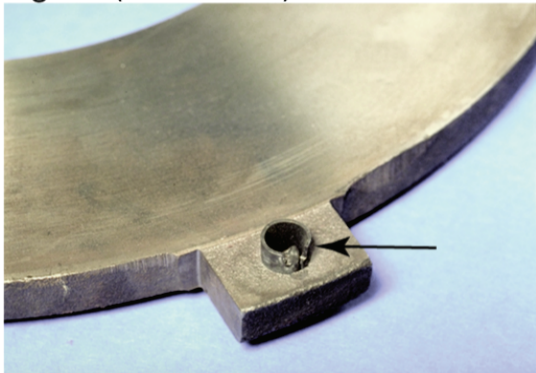

The damage done to the separator pins in Figures 32 and 33 (see arrows) is the result of using the wrong tool combined with excessive force. All four pins (on each intermediate plate) were damaged. When "setting" the four (4) roll pins, the proper tool would be a 1/4" flat nose punch used in conjunction with a small hammer (to help ensure light taps).

Fig 33

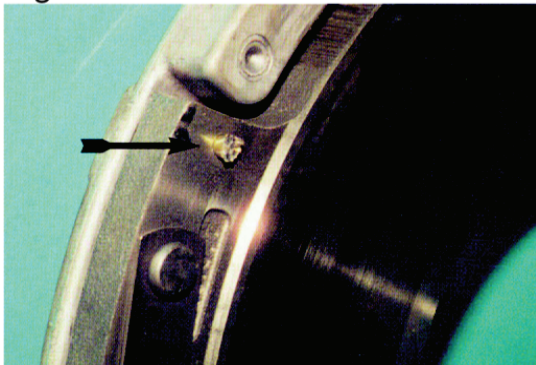

A damaged pin(s) can prevent the intermediate plate from retracting evenly when the clutch is disengaged, leading to a "poor release" complaint from the driver. The same complaint can also occur if the mechanic forgets to "set" the four (4) positive separator pins upon installation of the clutch. In you forgot to set the separator pins before installing the transmission, you can still set them through the inspection opening of the transmission.

## Failure - Aluminum Spacer Ring on the Intermediate Plate is Broken (Eaton Fuller Solo™ and Stamped Angle Spring 1402 only)

### Possible Causes

As shown in Figure 34 (see arrow), the aluminum spacer ring broke when it was bolted up backwards onto the flywheel.

**Note:** The cover assembly mounting hole pads (see arrow in Figure 35) have made an indentation (see arrow in Figure 36) onto the spacer ring mounting hole pads (flywheel side). This evidence will confirm that the spacer ring/intermediate plate assembly was indeed installed backwards. The words "Flywheel side" (refer to Figure 37) will face the flywheel when properly installed. Mishandling of this assembly during installation and/or removal can also cause the spacer ring to break. Some results of installing the intermediate plate backwards are as follows:

- A clutch that will not release properly.
- The release bearing position may be closer than normal to the transmission bearing retainer cap immediately upon clutch installation.
- A "cracking" noise as you tighten the (8) mounting bolts that secure the cover to the flywheel.

Fig 34 (SAS)



Fig 35 (SAS)

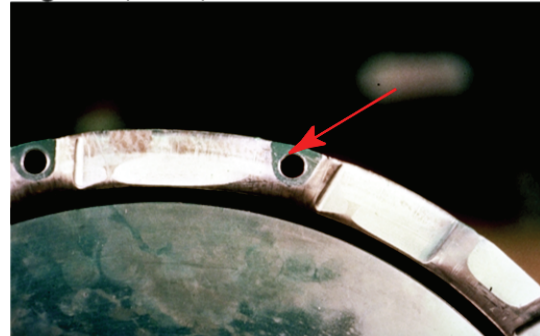

Fig 36

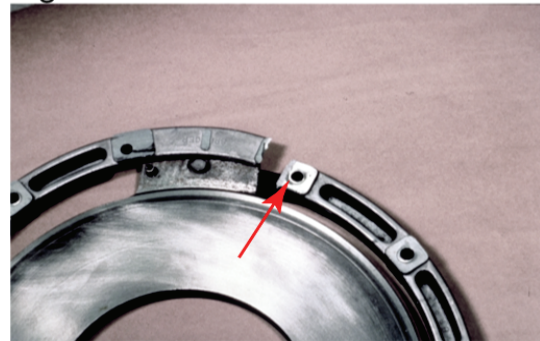

Fig 37 (SAS)



# Clutch Cover/Intermediate Plate

Fig 38 (AR)



## Failure - Lever Wear

### Possible Causes

As indicated by arrows in Figure 38, excessively worn levers are most likely the result of lack of maintenance. More specifically, lever wear can be the result of one or more of the following conditions:

- A dry, seized, or broken throw out bearing. Typical causes of a damaged bearing are:
  - a. Operating the truck without free-play
  - b. Constant riding of the clutch pedal

Both items 1 and 2 can cause the thinning and loss of bearing lubricant. They can also cause rapid lever wear due to constant contact with the bearing.

- A throw out bearing which fits too tightly on the front bearing cap stem. As a result, the return spring(s) (attached to the linkage or throw-out bearing) may not be capable of retracting the throw-out bearing away from the clutch levers. This will cause contact between these parts.
- Worn and/or binding linkages are causing the throw-out bearing to make "constant contact" with the clutch's three (3) release levers (Figure 38).
- Using a throw out bearing of inferior quality.

Fig 39



Fig 40



## Failure - Adjusting Linkage to Compensate for Easy-Pedal and Value Line Clutch Wear

### Possible Causes

Figure 39 shows the back of the pressure plate. This clutch has been properly adjusted (internally, using the adjusting ring) because each of the 6 levers has more than one witness mark (or lever fulcrum point).

Figure 40 depicts a clutch that has not been adjusted properly. As shown, there is only one witness mark per lever indicating that the clutch was improperly adjusted using the linkage.

**⚠ WARNING**

**Continually adjusting for clutch wear via the linkage can lead to the failures shown in Figures 4, 5, 25, and 57-58.**

## Clutch Disc Assembly Failures

### Failure - Oil Soaked Ceramic Disc

#### Possible Causes

After removal from the truck, the top half of this ceramic disc (Figure 41) was cleaned in order to reveal the contrast with the bottom half which is still oil soaked (Figure 30 shows the clutch cover that was run with this disc). Possible contributors to this condition are a leaking transmission and/or a leaking rear main engine seal.

Furthermore, oil on the disc buttons can cause the clutch to release poorly due to increased drag, and/or chatter/slip during engagement.

**Note:** Eaton does not recommend the reinstallation of any discs that are oil soaked because the button facings cannot be satisfactorily cleaned.

### Failure - None

#### Normal Wear Patterns

When troubleshooting Eaton Fuller Clutches, do not be concerned with the wear pattern (darkened areas) of the disc buttons (see Figure 42). More specifically, it is normal for the darkened areas to vary in color, size, and their relative position upon each button.

The exception to the above wear pattern is described in detail in Figure 46. The title of this description is: "Failure - Abnormal wear pattern at middle of disc button".

Fig 41 (AR)

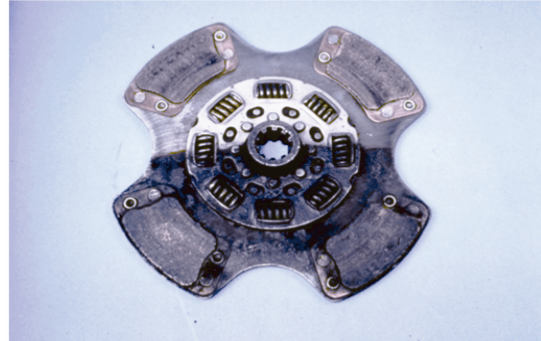

Fig 42



# Clutch Disc Assembly

Fig 43



## Failure - Grease on Buttons of Ceramic Disc

### Possible Causes

Figure 43 shows a disc with grease on its buttons, flywheel side. When this disc was removed from the truck, all four buttons had a heavy layer of grease on them. The left button has been cleaned to show the contrast with the grease-covered button on the right. Failing to remove the grease (rust preventative) from the flywheel (new or resurfaced) can cause this problem.

Fig 44



Greasing the splined areas of either the input shaft or disc hub(s) is not recommended because the grease can be spun onto the facing material of the driven disc(s) (refer to both arrows in Figure 44). The circled area in Figure 45 reveals the numerous paths which the grease took as it moved toward the buttons (facing material) of this ceramic driven disc. The photographs in Figures 44-45 are of the same driven disc.

**Note:** Eaton does not recommend the reinstallation of driven discs which have become contaminated with grease or oil.

A contaminated driven disc can cause one or more of the following problems:

- Poor release
- Clutch chatters during engagement
- Slipping clutch

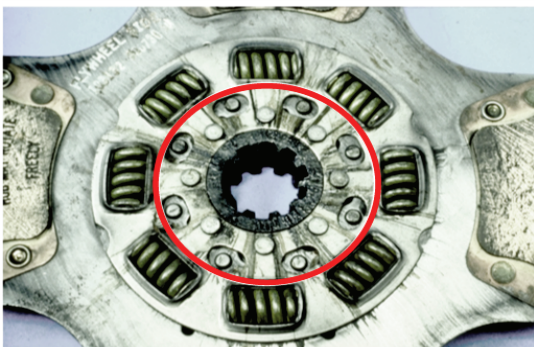

Also, grease on the splined areas of the input shaft/disc hub(s) will attract dirt, worn facing material, etc. which can impede the free movement of the disc hub on the input shaft, potentially causing a "poor release" complaint.

Fig 45

Fig 46

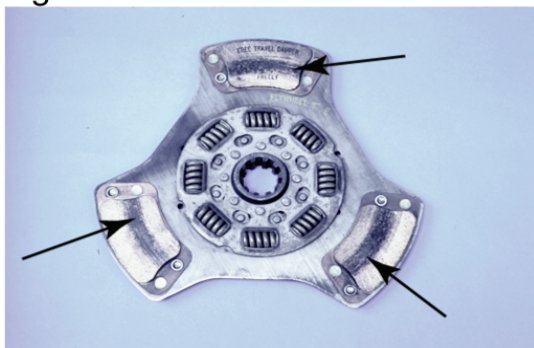

## Failure - Abnormal Wear Pattern at Middle of Disc Button

### Possible Causes

As shown by the dark areas of the three buttons in Figure 46, this disc was making major contact at the middle of each button on the flywheel side. The buttons on the opposite side had normal wear patterns. This abnormal wear pattern is found on service clutches (not original equipment), and is usually caused by a flywheel that is worn unevenly. This condition may result from improper resurfacing of the flywheel.

Before resurfacing any flywheel, consult your OEM service manual for proper procedures.

## Failure - Warped Driven Disc

### Possible Causes

Shown in Figure 47 is a brand new driven disc which was warped during transmission installation (as indicated by the dummy input shaft which is not perpendicular to the disc's hub). More specifically, the transmission was allowed to hang unsupported in the driven disc hub. A driven disc which has become bent due to improper installation techniques should not be reused because of the potential for a "poor release" complaint.

Fig 47



## Failure - Front Disc and Flywheel Interference

### Possible Causes

This failure can be attributed to one or more of the following specific conditions:

- The rivets of the disc (Figure 48) have been contacting the flywheel's mounting bolts. Some potential causes of this particular interference are as follows:
  - a. Loose flywheel mounting bolt(s) due to inadequate torquing.
  - b. Forgetting to tighten one or more of the mounting bolts when reinstalling the flywheel.
  - c. Installing an extra washer under the flywheel mounting bolt.
  - d. A flywheel which has been resurfaced too many times.
- The damper springs (see arrows, Figure 49 and 50) have been contacting the flywheel mounting bolts because the front driven disc was installed backwards. The driven disc (in Figure 49) had been wearing for a period of time before the interference occurred (as indicated by the full wear pattern on the ceramic buttons) while the one in Figure 50 was run for a very short period.

Fig 48



Fig 49 (EPP 14")

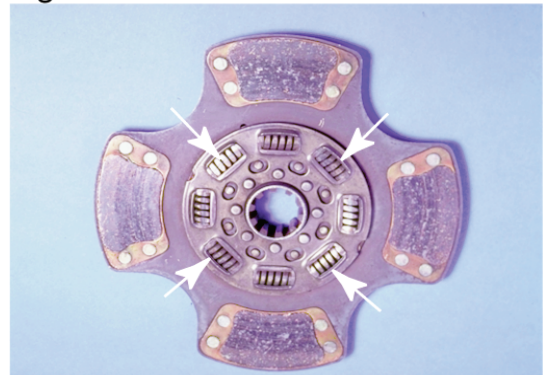
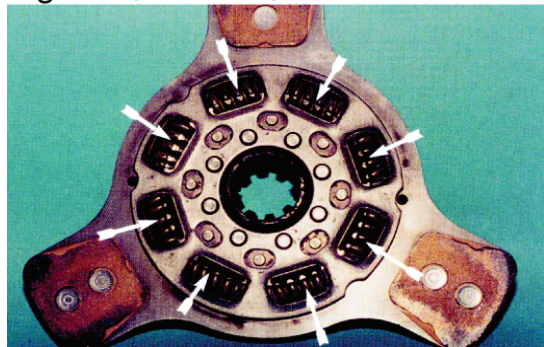

Fig 50 (SAS 1402)



# Clutch Disc Assembly

---

Fig 51



- A disintegrating pilot bearing which is interfering with both the hub and rivets of the driven disc (Figure 51).

Fig 52

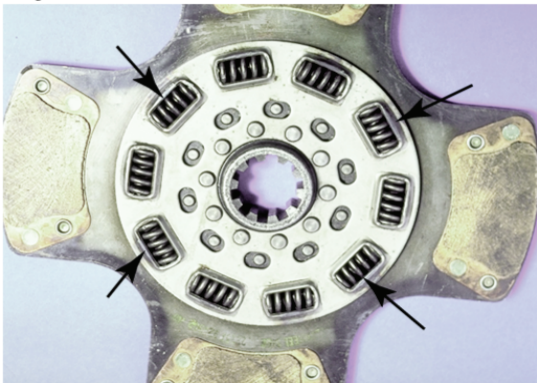

- Installation of the wrong clutch. Figure 52 (see arrows) shows the points of interference that resulted when a 10-spring driven disc was installed where an 8-spring was previously being run. In other words, the recessed area of the flywheel (mounting bolt cavity) was too small for the 10-spring driven disc. Before you mount the new clutch, consult the Eaton Installation Instructions (packaged with each Eaton Fuller Clutch) concerning "potential damper interference". A driver complaint, resulting from the above failure, can be:
  - a. The clutch does not release
  - b. The clutch is noisy during operation



## Failure - Burnt Discs

### Possible Causes

The failures shown in Figures 53-56 and 58 are the result of excessive heat due to prolonged slippage. Figures 53, 54, and 58 show discs that became so hot (due to slippage) that the ceramic material began to flow and eventually separate from the disc. Figures 55 and 56 show how the organic material separates from the disc due to bonding agent failure as a result of extreme heat. Burnt discs may result from:

- Lack of free pedal
- Constantly riding the clutch pedal
- Utilizing a slipping clutch as a brake on an incline
- Partial unloading of a clutch due to a binding linkage system, interference, etc.
- Installation and use of improper clutch (wrong application)
- Worn driven disc facings

Fig 53 Ceramic Disc

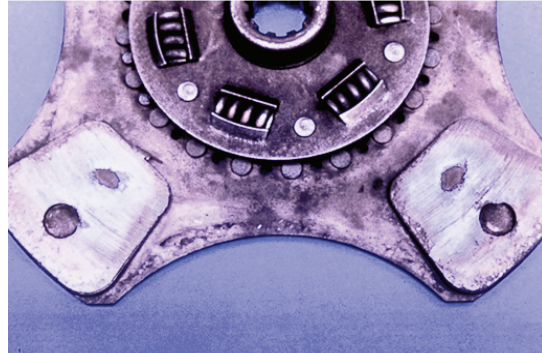

Fig 54 Ceramic Disc (SAS/severe)



Fig 55 Organic Disc

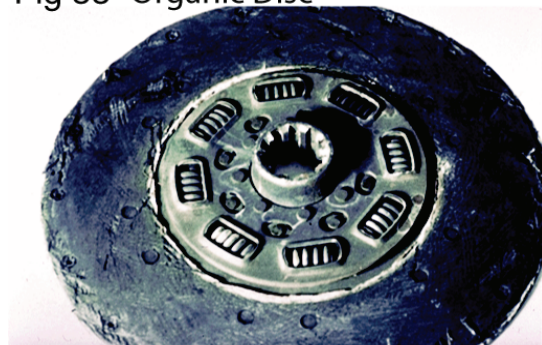
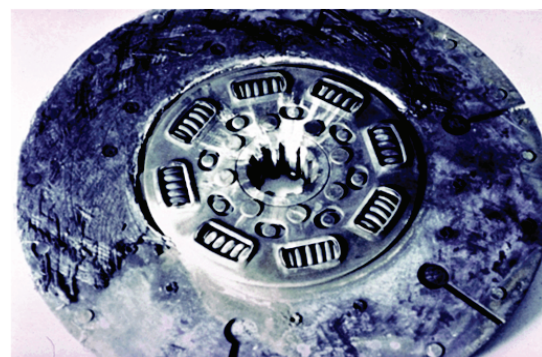
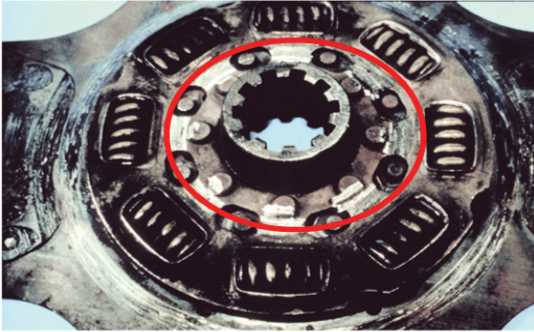

Fig 56 Organic Disc (Severe)



# Clutch Disc Assembly

Fig 57



## Failure - Rear Disc Interfering with Retainer Assembly

### Possible Causes

Figure 57 (see circle) shows the damage that will occur to the rear disc when it makes contact with the retainer assembly (refer to the arrow in Figure 25 concerning the subsequent damage to this part). This type of interference was so great that the clutch began to slip while engaged, thus creating enough heat to cause the ceramic buttons to self-destruct (Figure 58).

Fig 58



Fig 59

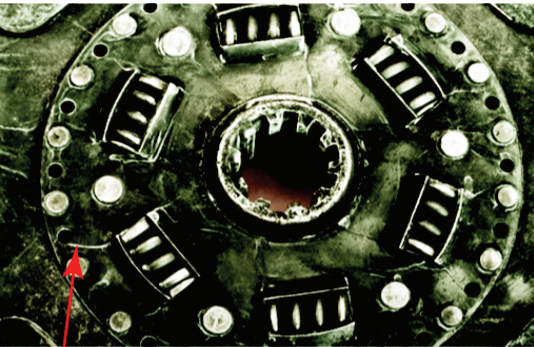

## Failure - Cracked Damper Cover

### Possible Causes

The cracks shown in Figures 59 and 60 (see arrows) can result from:

- Forcing the transmission input shaft into the disc hub during installation
- Allowing the transmission to hang unsupported in the driven disc(s) during installation
- Misalignment between the engine housing and the transmission bell housing

Fig 60

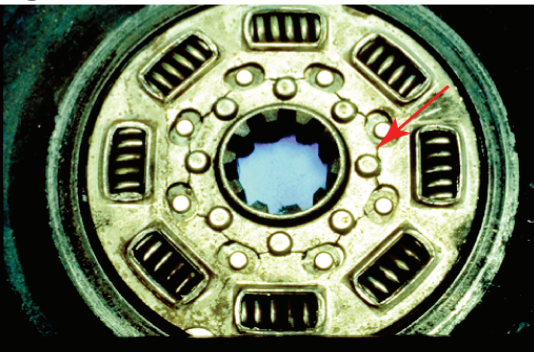

## Failure - Hub of Rigid Driven Disc Worn Excessively or Fractured

### Possible Causes

Figure 61 shows a disc hub that has worn excessively (see arrow) and has also broken away from the disc. Note the narrow width of each spline compared with those on a new disc. Figure 62 reveals a hub in which the splines have been completely “pounded” out (see arrow.) The typical cause of worn splines is either torsional vibrations or misapplication of the clutch. A broken or cracked disc hub can be attributed to one or more of the following:

- A severe shock load, such as engaging the clutch while coasting down a hill.
- Misalignment between the transmission bell housing and engine housing due to loose transmission mounting bolts and/or worn mating faces of either housing.
- Misapplication—a rigid disc should not have been used, but rather a dampened disc assembly (D.D.A.).
- Torsional vibrations from the engine.
- Excessive flywheel runout.
- Allowing the transmission to hang unsupported in the driven disc during installation.

## Failure - Non-Eaton Fuller Material

### Possible Causes

Figure 63 is the disc of a non-Eaton rebuilt clutch. It is an old disc that was rebuilt, as indicated by the presence of dampener springs encased in rubber (see arrow). Consequently, the rubber covered springs can make the disc act as a rigid disc, thus increasing wear to the input shaft and the disc itself. As shown by an arrow in Figure 64, parts of this disc have broken. Also, the springs are wrapped in rubber to prevent any worn ones from falling out after the disc is put into service. Contrast this with the Eaton Fuller Reman Clutches in which only new discs are used.

Fig 61

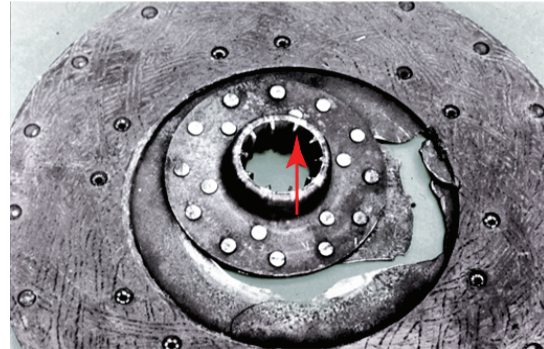

Fig 62

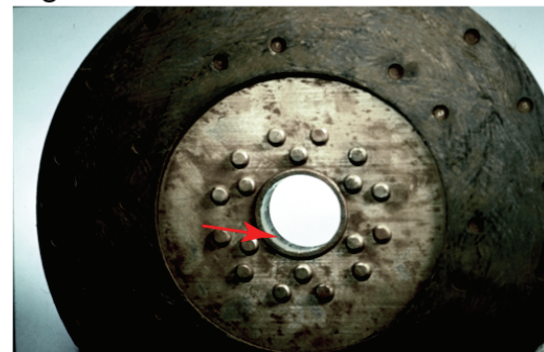

Fig 63

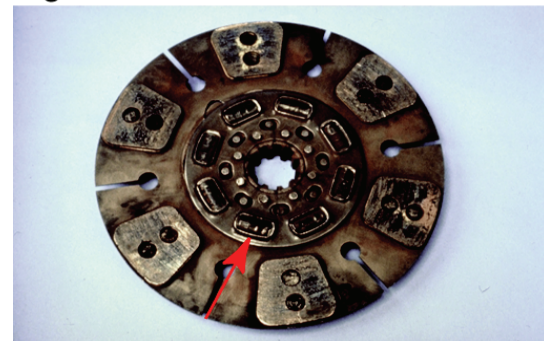

Fig 64



# Clutch Disc Assembly

---

Fig 65

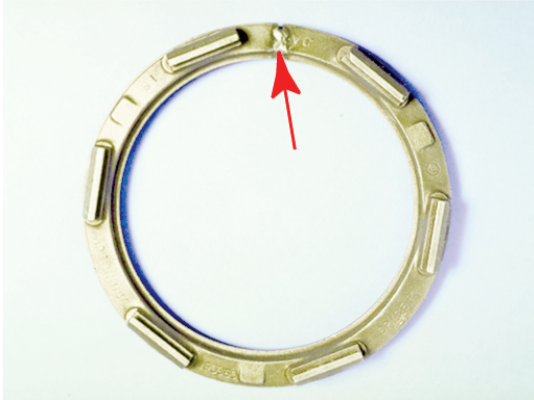

Note also the adjusting ring pictured in Figure 65. It was removed from a non-Eaton rebuilt clutch. This ring was cut open on one side, spread apart, and then welded (see arrow) at a larger diameter to prevent the adjusting ring from becoming loose once it was reinstalled. (Eaton Clutch does not weld adjusting rings, but rather discards any rings that are too loose.)

Fig 66

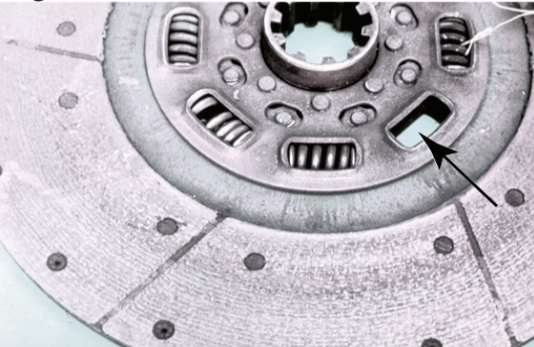

## Failure - Broken and/or Missing Dampener Springs

### Possible Causes

A broken dampener or missing spring (see arrow in Figure 66) may result from severe shock loads or excessive torsional vibration from the engine in excess of what the dampener springs can absorb. If the clutch disc is not original equipment, verify whether it matches the vehicle's application.

## Failure - Burst Driven Disc, Friction Material Separates from Disc

### Possible Causes

This type of failure is caused by very high RPM encountered when coasting in gear with the clutch released. In this situation, the rear wheels are driving the disc through the multiplication of the rear axle and transmission ratios. This can result in excess of 10,000 RPM which is beyond the burst strength of the facing material.

Example: Coasting a tractor down an unloading ramp can burst a driven disc. See Figures 67, 68, and 69.

Fig 67 (AS)



Fig 68 (AR)

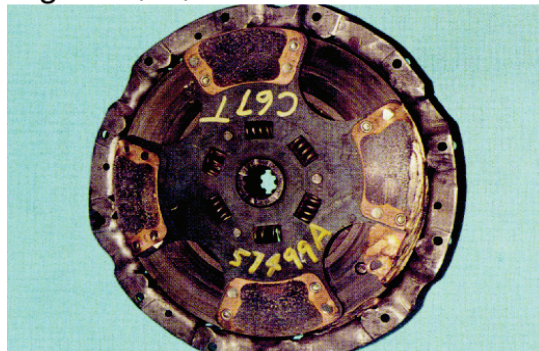

Fig 69 (close-up of Figure 68)



Fig 70



## Failure - Worn Driven Disc Facings

### Possible Causes

When the rivets (those which secure the facing material to the driven disc) begin to contact either the pressure plate, intermediate plate, or flywheel, then the entire clutch assembly is ready for replacement. Referring to the arrow in Figure 70, this rivet has been making contact with the pressure plate shown in Figure 17. Note the “shiny” appearance of the rivet and also the resulting “groove” on the pressure plate.

# Adjusting Mechanisms and Clutch Brakes

## Adjusting Mechanism and Clutch Brake Failures

Fig 71

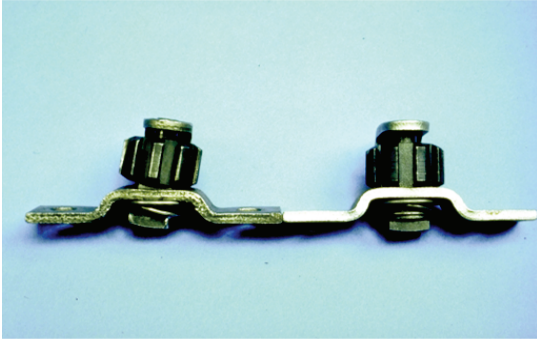

Fig 72

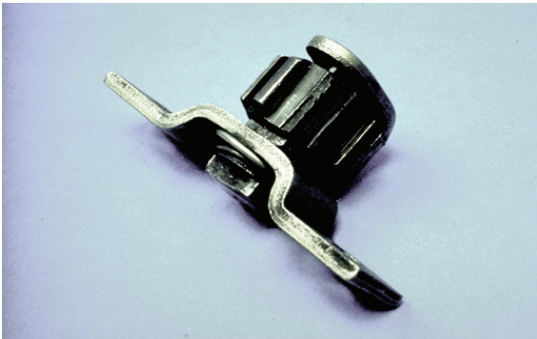

Fig 73

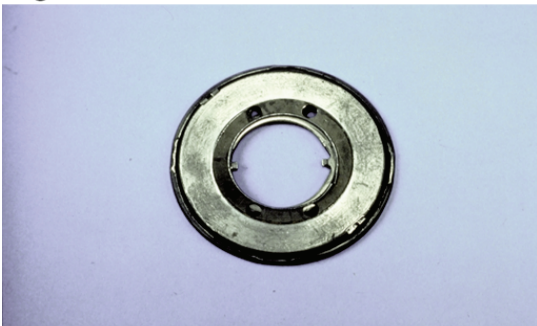
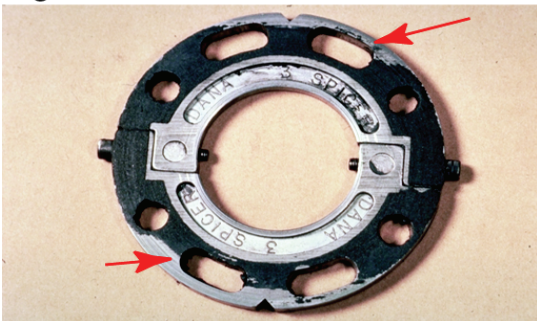

Fig 74



### Failure - Bent/Broken Kwick-Adjust® Mechanism

#### Possible Causes

Referring to Figure 71, the kwick-adjust mechanism at the right is a normal and properly functioning adjuster while the one at the left has been damaged, as evidenced by the bent mounting bracket. The one pictured in Figure 72 also has a bent mounting bracket in addition to some broken gear teeth (see arrow). Some causes of these failures can be:

- Forgetting to depress the kwick adjuster while attempting to rotate the gear.
- Only partially depressing the mechanism while attempting to rotate the gear.
- Attempting to rotate the gear while the clutch pedal is in the up position (clutch is not released).

### Failure - Worn Clutch Brake

#### Possible Causes

As shown in Figure 73, the facing material on this clutch brake is completely worn away. Figure 74 shows a clutch brake that is partially worn (see arrows). Both types of failures can be attributed to one or more of the following:

- A clutch that is releasing poorly (for corrective action, see the troubleshooting section titled “Poor Release”), thus making it more difficult for the clutch brake to stop the transmission input shaft.
- “Hitting” or engaging the clutch brake when the transmission is in gear and the vehicle is in motion.
- The clutch brake was set too high.
- Installing the new clutch brake in front of a worn/rough transmission bearing retainer cap.
- Clutch brake is simply worn out.

**Note:** A worn clutch brake should be replaced. Be sure to always check the transmission bearing retainer cap for any wear and replace if necessary (see Figure 3).

## Solo Clutch Failures

### Failure - Solo Cam Tab Broken Off

#### Possible Causes

In Figure 75, the tab was broken when someone was attempting to change the adjustment of the clutch. The clutch cannot break the tab. Many times the tab is broken to change the bearing to clutch brake distance when it is in the proper position. Do not attempt to change the clutch adjustment before measuring the release bearing to clutch brake distance.

**Note:** Consult the troubleshooting guides for help. If the release bearing is set to the correct dimension, do not attempt to use the cam tab to change the adjustment to the wrong dimension and break off the tab. Troubleshooting guides: CLSM0100 (Medium-Duty) and CLSM0200 (Heavy-Duty).

### Failure - Solo Over Adjust Problem

#### Possible Causes

Measure the distance between the release bearing and clutch brake. Correct distance should be between .490" and .560" with the pedal up (Figure 76). If the bearing is close to the clutch brake and the clutch has not been removed and re-installed on the fly-wheel, then an overadjust might have occurred. Consult troubleshooting guides for help. Follow the fault tree for proper diagnosis and correction.

### Failure - Bushing Wear and Bushing Failure

#### Possible Causes

As shown in Figures 77 and 78, incorrect lube or not enough lube can cause a failure. External contamination will also cause wear to the bushing. The transmission input shaft may be rough and require replacement. Use approved/compatible lube. (High quality N.L.G.1 #2 or #3 lithium soap grease with E.P. additives 325 degree operating temperature or Roadranger MP-2). Apply ample lube and let it flow out of the opening from the bearing housing. Apply additional lube onto the transmission shaft to ensure the bushing will have proper lube. Apply lube to the tips of the release yoke.

Fig 75

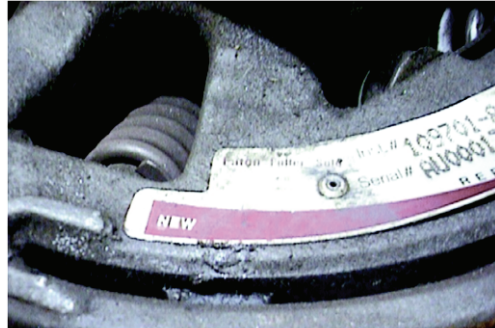

Fig 76



Fig 77



Fig 78



# Solo Clutch

---

Fig 80



## Failure - Solo Adjustment Rings Contaminated - Solo Stops Adjusting

### Possible Causes

If there is excessive amounts of contamination allowed into the clutch housing, the Solo may stop adjusting and there will be a loss of free pedal in the cab (see Figure 80). Check to see if the inspection cover has been removed. In severe dust applications, it may be necessary to seal all openings in the clutch housing.

Eaton has created a tool that may help free up the clutch to allow it to continue adjusting. #CLPISOLOTOOL can be obtained by calling 800-826-HELP (4357).

Fig 81



## Failure - Worn Wear Pad on Release Bearing caused by Running the Truck without Free Pedal

### Possible Causes

When the clutch is properly maintained, there should always be free pedal in the cab. This will prevent fork contact with the bearing wear pads and reduce the wear to the pads and the release fork (Figure 81). Follow adjustment instructions for correct clutch and linkage adjustment. Adjust the clutch before free pedal is lost. Apply grease to the yoke fingers to reduce friction when the clutch pedal is stroked.



## Miscellaneous Failures

### Failure - Cross Shaft Wear

#### Possible Causes

Figure 82 is an example of a worn cross shaft (release shaft). A worn cross shaft (see circle) will occur after high mileage and will be accelerated by a lack of lubrication. Some problems associated with worn cross shafts (and/or worn linkage systems) are:

- Sporadic changes in the amount of free play in the cab
- A binding condition in the linkage system
- Erratic engagement of the clutch
- Side loading of the release bearing housing

As a result, a typical complaint might be that it is impossible to maintain proper clutch adjustment. To prevent future clutch problems, always inspect the linkage system for excessive wear and/or binding conditions before installing the new clutch. Be sure to replace any worn components that might hinder clutch operation. Also, remember to lubricate the linkage pivot points.

### Failure - Seized/Dry Pilot Bearing

#### Possible Causes

Once removed from the flywheel, a failed pilot bearing can be identified by one or more of the following conditions:

- The bearing is dry; it is difficult to turn (rough) or completely seized. Any condition which causes a dry bearing will have been accompanied by a noise complaint while it was in the vehicle.
- A damaged ball bearing cage (see arrow in Figure 83).
- A step is worn into the inner race. The step is caused when the input shaft spins within the inner race, a direct result of the seized pilot bearing.
- The seal is missing and/or damaged because of excessive heat generated by the dry bearing.

A typical complaint associated with a failed pilot bearing (other than noise) is poor release. Poor release can be the result of one or more of the following conditions:

- The outer race of the bearing fits too tightly in the flywheel.
- The inner race of the bearing fits too tightly on the input shaft.

Fig 82

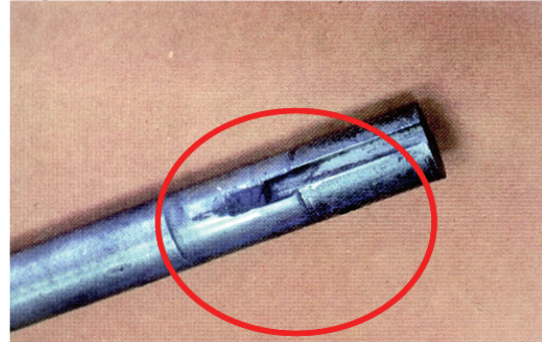
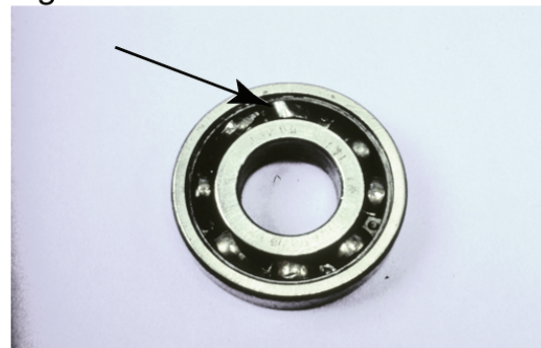
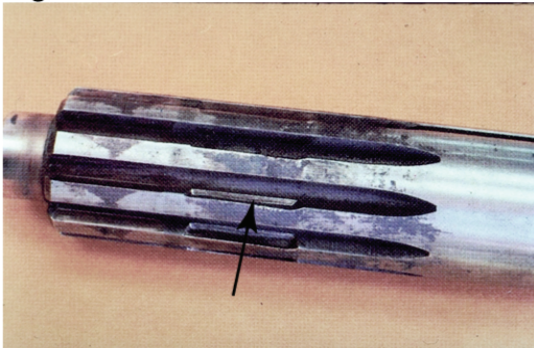

Fig 83



- A seized or rough pilot bearing will allow the input shaft to continue rotating even when the clutch is completely disengaged. As a result, the clutch brake can become damaged and eventually fail (see Figure 73 of “Worn Clutch Brake”).
- If the bearing fits too loose, the end of the input shaft won’t be properly fitted. Also, if the fit is loose, the races will skid rather than rotate the ball bearings.

Fig 84



## Failure - Input Shaft (Drive Gear) Spline Wear

### Possible Causes

Drive gear spline wear will cause clutch release problems since the driven discs cannot slide freely on the splines. This is especially true if new driven discs are installed on a worn input shaft (Figure 84). Excessive spline wear can be attributed to torsional vibrations. This type of wear can be eliminated or lessened by the use of dampened driven discs. Spline wear will also occur on the mating driven disc hubs (see Figures 61-62). Misalignment can also be a factor in abnormal spline wear. It is important to always inspect the input shaft for wear before installing a new clutch. If worn, it is recommended that a new input shaft be installed to eliminate possible clutch problems later on.

Fig 85



## Failure - Galled Input Shaft

### Possible Causes

This failure resulted when the clutch’s release sleeve was being “side loaded” onto the input shaft (Figure 85). A worn linkage system and/or excessive wear on the release bearing “wear pads” and “release yoke fingers” can cause this side loading condition.

A galled or rough input shaft (in the non-splined area) will damage the bushing(s) of not only the original clutch, but also that of the newly installed clutch. As a result, make sure you replace the input shaft and any worn linkage components to prevent the failure from being repeated.

## Failure - Worn Fingers on Release Yoke

### Possible Causes

The yoke at the left is brand new. The yoke at the right is worn excessively and should be replaced. This wear can be the result of constant riding of the clutch pedal by the driver, and/or failure to maintain free play up in the cab (see Figures 28 and 29 for the resulting damage that can occur to the release bearing).

Consequently, there will be continual contact between the release yoke fingers and the release bearing wear pads. A yoke that is worn excessively may hinder the engagement/control of the clutch. See Figures 1, 5, and 10 for additional photos and descriptions of release yoke failures.

Fig 86

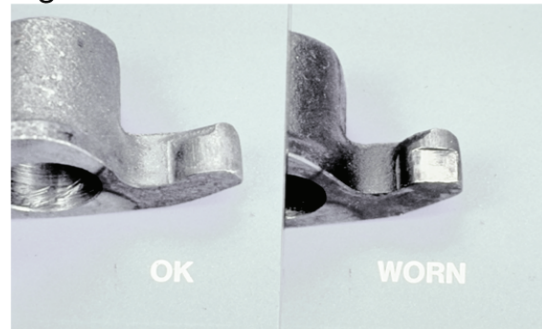

# Pilot Bearing

---

## Pilot Bearing Recommendations

The following pilot bearings are currently the minimum Eaton Clutch Division recommends. The operating temperature that the pilot bearing sees has increased in the last several years. This creates operating conditions that are no longer acceptable to the standard pilot bearings and grease. In addition, the life of the clutch has increased. The use of high temperature grease and Viton seals are now mandatory to ensure adequate bearing life. Pilot bearing failure usually results in a warranty claim for drag or clutch noise. This results in a claim against Eaton Clutch.

Below is a list of the recommended Pilot Bearings. All of these bearings have Viton seals and high temperature grease in addition to a C3 fit. It is acceptable to use synthetic high temperature grease and a C5 fit if desired.

Vendor	Seal Type	Bearing Series		
		6205 Bearing	6306 Bearing	6006 Bearing
NTN	VITON	6205 LLUAV/C3	6306 LLUAV/C3	6006 LLUA1 C3/LX16
KOYO	VITON	6205 2RKF-S2/C3	6306 2RKF-S2/C3	
NSK	VITON	6205 DDU7/C4 ENS	6306 DDU7/C4 ENS	6006 DDWA18A C4/ENSS
SKF	VITON	6205 2RS2/C3	6306 2RS2/C3	
FED-MOG	VITON	6205 VV/C3	6306 VV/C3	

## Clutch Troubleshooting

This section will provide the service technician assistance to diagnose a malfunctioning clutch using the following 3-step process:

1. Identify the customer's specific "complaint".
2. Investigate the "possible causes" that can be contributing to the customer's complaint.
3. Perform appropriate "corrective actions" to remedy the customer's complaint.

Additionally, it is intended that a thorough reading/understanding of the previous section (Failure Analysis) and the following section (Troubleshooting) will:

1. Allow the service technician to solve some complaint problems without removing the clutch.
2. If clutch removal is necessary, these sections will give the technician the appropriate information for determining why the clutch may have failed, thus preventing a possible reoccurrence of the complaint.

It is important to note that the statements/photos of failed components represent quality Eaton Fuller Clutch parts which were subjected to abuse and/or misapplication. Consequently, the failures pictured in no way represent defective Eaton Fuller Clutch components.

## Checklist for Poor Releasing 15-1/2" Clutch

1. Typical customer release complaints:

- Creeping with clutch pedal depressed.
- Grinds going into first or reverse gear (given adequate time and vehicle stopped).
- Clutch brake does not stop transmission.
- Difficult to get out of gear (first & reverse).

2. Investigate the problem.

- What is the customer's complaint?
- Questions to confirm clutch release complaint:
  - a. Which gears are giving a problem?
  - b. Does the clutch brake stop the transmission?
  - c. How far off the clutch brake can you still pull in and out of gear?
  - d. Does it grind going into gear or is it hard to pull in?

3. Measurements/checks to make:

- Measure release bearing travel (take the free pedal out by pushing lightly on the pedal with your hand to load bearing).
- Measure clutch brake squeeze (hint: use a business card or a .010" feeler) Response: Minimum 1/2".
- While pushing pedal down, check linkage for interference or premature bottoming.

4. Use a 1/4" diameter flat-nosed drift and lightly tap each of the four separator pins to ensure they are against the flywheel.

5. Does the clutch release?

# Troubleshooting

## Pull Type Clutches - Poor Release

Complaint	Possible Causes	Corrective Action
Poor Release	Intermediate plate sticking on drive lugs due to cocked drive pins (AS and EP 1402 only) (see Figures 18 - 19)	Drive pins must be 90° square to the flywheel surface with .006 minimum clearance between drive pins and intermediate plate slots.
	Pressure plate not fully retracting	Check pressure plate return springs to see if bent, stretched, or broken. These springs can be replaced through the inspection opening. Transmission removal is not necessary.  Verify that the release bearing travel is 1/2"—9/16". Determine if the lever nose is out of the groove in the release sleeve retainer. If it is, be sure to reinstall.
	Excessive release bearing travel, causing lever to contact pressure plate (in excess of 5/8")	Adjust to 1/2"—9/16" release bearing travel.
	Incorrect pedal height	Set the pedal height so you can obtain: —1/2" to 9/16" release bearing travel —1/8" free travel at the release yoke and —1/2" to 1" clutch brake squeeze Consult the truck service manual or Eaton's Installation Instructions.
	No clutch brake squeeze	1/2"—1" required.
	Damaged bushing in the release bearing sleeve assembly	Replace cover.
	Cover assembly not properly seated into pilot of flywheel	Reseat into flywheel. Use crisscross pattern when tightening mounting bolts.
	The spacer ring & intermediate plate assembly (Solos and SAS 1402 only) was bolted up backwards onto the flywheel (see Figures 34 - 37)	If the clutch cover has already been bolted to the flywheel, it is imperative that it be replaced with a new intermediate plate assembly because permanent damage may have occurred to the drive straps and spacer ring. Also, thoroughly inspect the cover for any damage and replace if damaged.
	The intermediate and/or pressure plate is either cracked or broken (see Figures 13 - 14 and 25)	Replace any damaged parts. This failure is caused by driver abuse or excessive heat as indicated by the following: —Holding vehicle on hill with the clutch —Overload —Starting off in the wrong gear —Wrong cover assembly installed allowing clutch to slip (misapplication) —Intermediate plate hanging up, allowing clutch to slip

## Pull Type Clutches - Poor Release

Complaint	Possible Causes	Corrective Action
<p>Poor Release (Continued)</p>	<p>Release sleeve bushing is contacting the transmission input shaft due to a side loading condition. This condition can be the result of one or more of the following items:</p> <ul style="list-style-type: none"> <li>—Cross shafts protruding through the release yoke</li> <li>—Finger(s) of release yoke are bent</li> <li>—Clutch cover is not mounted concentric and/ or not properly seated into the flywheel pilot</li> <li>—Misalignment between the transmission bell housing and engine housing</li> <li>—Loose transmission mounting bolts</li> <li>—Improper setup of linkage</li> </ul>	<ul style="list-style-type: none"> <li>—Check for protruding cross shafts.</li> <li>—Install a new release yoke.</li> <li>—When mounting clutch cover to the flywheel, always tighten the mounting bolts to their proper torque using the crisscross pattern.</li> <li>—Refer to Eaton’s Installation Instructions on the proper techniques for checking misalignment.</li> <li>—Tighten bolts to proper torque.</li> <li>—Thoroughly examine the linkage to determine if it can be contributing to a side loading condition.</li> </ul>
	<p>Driven disc distorted or warped (see Figure 47)</p>	<p>Damage to driven discs can be caused by poor installation methods. Do not force transmission drive gear into disc hubs. This will distort or bend driven disc causing poor release. Also, do not allow transmission to hang unsupported. Replace any distorted or warped discs.</p>
	<p>Disc(s) installed backwards (see Figures 49 &amp; 50) or front and rear discs were switched with each other</p>	<p>Install new discs. Also, investigate the clutch cover for any damage. Replace if damaged.</p>
	<p>Spline worn on main drive gear of transmission. (see Figure 77)</p>	<p>Replace drive gear and check driven disc hubs for excessive wear. If worn, replace disc. Check flywheel housing alignment of engine and transmission. Make sure driven discs slide freely on drive gear splines.</p>
	<p>Flywheel pilot bearing fits either too tight or too loose in the flywheel and/or end of input shaft</p>	<p>Check pilot bearing for proper fit.</p>
	<p>Damaged or dry (rough) pilot bearing (see Figure 76)</p>	<p>Replace with new bearing.</p>
	<p>Failure to use the anti-rattle springs packaged with all 14” AS and EP Super Duty clutches (see Figures 20 - 22)</p>	<p>Always use new anti-rattle springs.</p>
	<p>(3) Anti-rattle springs were installed backwards (see Figures 23 - 24)</p>	<p>Install them so the rounded sections are pointing toward the flywheel/engine.</p>
	<p>Failure to set the positive separator pins during clutch installation</p>	<p>It is important to note that the procedure for setting the positive separator pins (model 1552, Solo &amp; SAS 1402 clutches) can be performed while the transmission is installed. The steps are as follows:</p> <ol style="list-style-type: none"> <li>1. Remove the transmission inspection hole cover.</li> <li>2. Rotate the clutch cover until one of the holes (for setting the pins) is at the 6 o’clock position.</li> <li>3. Using the appropriate tool, lightly tap the separator pin to verify that it is seated against the flywheel.</li> <li>4. Repeat steps 2 and 3 for the remaining three separator pins.</li> <li>5. Reinstall the transmission inspection hole cover</li> </ol> <p>For additional information, refer to Eaton’s Installation Instructions.</p>

Troubleshooting

# Troubleshooting

## Pull Type Clutches - Poor Release

Complaint	Possible Causes	Corrective Action
Poor Release (Continued)	Bent/damaged positive separator pin(s) (see Figures 31 - 33)	1. Be sure to use the proper tool when setting the pins. 2. Take great care when handling the intermediate plate.
	The release yoke bridge is contacting the cover assembly at the full release position (clutch pedal to floor) (see Figures 1 - 2)	It is highly recommended that the (6) six items listed next to Figures 1 and 2 be thoroughly investigated before installing a new clutch.
	Damaged or non-functioning clutch brake (see Figures 73 - 74)	Install new clutch brake when installing a new clutch and/or replace existing brake with 2 piece (Kwik-Konnect type).
	Rust preventative, i.e. never seize, grease, etc. on transmission input drive gear (see Figures 43 - 45)	Drive gear should be clean and dry before installing discs.
	Incorrect use of clutch brake when shifting into 1st gear. Sometimes when applying the clutch brake with the vehicle on a grade, the transmission gears can become locked together due to the applied torque, making it difficult to shift into and out of gear.	Let up on the clutch pedal a few inches in order to disengage the clutch brake. Doing so will allow the input shaft to roll-over slightly, eliminating the locking condition of the transmission gears and allow for effortless shifting.
	Facing of driven disc assemblies are coated with oil or grease (see Figures 41, 43 - 44)	Replace the driven disc assemblies. Cleaning of old discs is not recommended.
	Foreign material on the internal workings of the clutch cover (dirt, chaff, salt, etc.)	Remove foreign material. Ensure that the transmission inspection hole cover is reinstalled to minimize future problems.



## Noisy/Rattling

Complaint	Possible Cause	Corrective Action
Noisy/Rattling	Excessive flywheel runout	Consult Eaton's Installation Instructions.
	Corrosion of disc hubs to transmission input shaft	Clean the mating parts to ensure that the discs slide freely over input shaft.
	Engine idling too fast	Readjust engine to proper idling speed.
	Clutch release bearing is dry or damaged (see Figures 28 - 29)	Lubricate the bearing. If the noise persists, install a new clutch cover (the release bearing will be included with the cover).
	Flywheel pilot bearing is dry or damaged (see Figure 76)	Replace flywheel pilot bearing.
	Bridge of the yoke hitting clutch cover	Refer to the section titled: "Failure - yoke bridge rubbing into clutch cover," Figures 1 - 2.
	Fingers of release yoke hitting clutch cover	Refer to the section titled: "Failure - yoke fingers rubbing into clutch cover," Figures 4 - 5.
	Failure to use the transmission inspection hole cover	Re-install the cover.
	Failure to use anti-rattle springs (AS and EP 1402 Super-Duty only) (see Figures 20 - 22)	Always install the new anti-rattle springs packaged with each 14" Super-Duty clutch.
	Worn sleeve bushing	Investigate for any side loading conditions on the release bearing housing. Determine the cause, being sure to correct before installing the new clutch.
	Linkage system is frozen, improperly lubricated, worn excessively, has missing parts (washers, etc.), or the linkage itself is rattling excessively	Clean, lubricate and reassemble or replace missing/worn parts.
	Idle gear rattle coming from the transmission	—Specify driven disc assemblies which feature Free-Travel design. —Check the engine for the correct idle speed. Consult the OEM engine manual.
	Dampener spring cover of the driven disc assembly interfering with the flywheel (Figures 48 - 52)	Install correct clutch assembly.
Rivets of the rear disc are interfering with the retainer assembly (see Figures 25 and 57)	Adjust the clutch internally (via the adjusting ring), not externally (via the linkage system).	
Clutch is loose on flywheel (see Figures 8 - 10)	Install a new clutch assembly and eight new mounting bolts.	

# Troubleshooting

## Vibrating Clutch

Complaint	Possible Cause	Corrective Action
Vibrating Clutch	Loose flywheel	Retighten flywheel mounting bolts to the proper specifications.
	Worn universal joints	Replace worn parts.
	Improper phasing of driveshaft	Investigate for correct yoke phasing.
	Driveshaft is not balanced	Balance and straighten driveshaft. Also, ensure that no balance weights have come off the driveshaft.
	Incorrect driveline angles	Shim drivetrain components to equalize u-joint angles.
	Flywheel is not balanced	Balance the flywheel.
	Pilot area of the clutch is not completely seated into flywheel	Ensure that no dirt, burrs, etc. are preventing the cover from completely seating into the flywheel mounting surface.
	Failure to tighten the clutch cover mounting bolts, using a criss cross sequence, can cause an out-of-balance condition. Loose mounting bolts can also induce this condition (Figures 8 - 10)	Consult Eaton Clutch Service Manual.
	Damaged, loose, or worn out engine mounts	Replace any damaged/worn parts. Retighten all loose bolts to proper specifications. Refer to the OEM engine manufacturer's service manual.
	Misfiring of engine	Refer to OEM engine manufacturer's service manual.
	Excessive flywheel runout	Refer to Eaton's Installation Instructions.
	Rivets of the rear disc are interfering with the retainer assembly (see Figures 25 and 57)	Adjust the clutch internally instead of externally.
	Clutch is loose on flywheel (see Figures 8 - 10)	Install a new clutch assembly and eight new mounting bolts.
	Insufficient amount of free travel. When the clutch was initially installed, the linkage was not adjusted to obtain a full 1/8" free travel	After first adjusting the clutch for 1/2"-9/16" release bearing travel, adjust the linkage to obtain an 1/8" free travel (distance between the release yoke fingers and the release bearing wear pads) travel.
	Misapplication of clutch, causing premature wear	If a service clutch, determine whether the clutch is properly specified for the vehicle's particular application.
Starting out in too high a gear may lead to premature clutch wear	Start the vehicle in the proper gear. Refer to item 1 of "Factors That Effect Clutch Performance".	
Worn cross shafts and/or linkage system	Investigate entire linkage system to determine if it is binding or operating sporadically and/or worn excessively.	
Clutch discs wore down to rivets	Install new clutch.	
Riding of clutch pedal, causing premature wear	Refrain from using the clutch pedal as a foot rest.	

## Vibrating Clutch

Complaint	Possible Cause	Corrective Action
	Holding the vehicle on an incline by using the slipping clutch as a brake. Doing this can cause premature wear.	Refrain from using the clutch pedal as a brake.
	Sporadic changes in the amount of free play/free travel due to excessive crankshaft end play	Consult the engine OEM Service Manual.

## Too much Free Play on Solo Clutch

Complaint	Possible Cause	Corrective Action
Too much Free Play on Solo Clutch	Failure to install a clutch brake when one is required. This condition will cause the Solo's release bearing to adjust closer than normal to the transmission's bearing retainer cap and will also cause the wear tab to move toward the half worn position.	Reset the wear tab to the new position. Install a 2-piece Eaton Fuller Clutch Brake. Readjust the Solo using the normal adjusting procedures.
	Solo Clutch has over adjusted (release bearing is less than .500" {standard stroke Solo} or .430" {short stroke} from the transmission)	Reset the wear tab to the new position. Readjust the Solo using the normal adjusting procedures.
	Failure to properly set-up the clutch linkage	Reset the linkage to obtain a free travel (at the yoke) range of 1/16" -1/8".
	Nothing is wrong. It is normal for the free play to increase during the Solo's "Breaking in" period.	None is required, but if the additional free play is objectionable, you may readjust the linkage until you have 1/16" -1/8" of free travel at the release yoke.

## Clutch Slippage

Complaint	Possible Cause	Corrective Action
Clutch Slippage	No free pedal	Readjust clutch. Refer to adjustment instructions found in Eaton's Installation Instructions.
	Release mechanism binding	Free up mechanism and linkage, check clutch adjustment. Refer to adjustment instructions found in Eaton's Installation Instructions.
	Failure to remove shipping/resetting bolts (Solo HD & MD)	Remove shipping/resetting bolts.
	Grease or oil on facings (see Figures 41, 43 - 44)	Replace driven disc assembly.
	Driver riding clutch pedal	Refrain from riding clutch pedal.
	Overloaded clutch	Verify that the proper clutch has been specified for the vehicle's application.

# Troubleshooting

## Chattering, Erratic Engagement, Clutch Grabs, truck is difficult to launch

Complaint	Possible Cause	Corrective Action
Chattering, Erratic Engagement, Clutch Grabs	Input shaft spline wear (see Figure 77)	Replace input shaft.
	Clutch is worn out - the driven disc assembly(s) have worn down to the facing rivets (see Figure 70)	Replace all worn components.
	The linkage system is not operating freely, it is binding and/or worn excessively (see fig. 75)	Replace all worn parts, being sure to lubricate according to the OEM Service Manual.
	Grease/oil on the disc(s) facing material (see Figure 41, 43 - 44)	Replace disc(s).
	Loose engine mounts	Retighten to OEM specs.
	The fingers of the release yoke and/or the wear pads on the release bearing are worn excessively (see Figures 29 and 79)	Replace all worn parts.
	The electronic engine is not programmed properly regarding clutch engagement torque.	Consult with OEM engine manufacturer.

## Push - Type Clutches

### Poor Release

Complaint	Possible Cause	Corrective Action
Poor Release	Insufficient amount of clutch pedal height may prevent the throw out bearing from traveling far enough to disengage the clutch	Consult the OEM Service Manual and/or Eaton's Installation Instructions.
	Incorrect throw out bearing was installed. A throw out bearing assembly that is too short cannot travel far enough to enable full disengagement of the clutch	Install the correct throw out bearing.
	Excessive free pedal in the cab - the clutch cannot fully disengage	Consult the OEM Service Manual.
	Throw out bearing is hanging up on the quill (stem) of transmission	Consult the OEM Service Manual.
	Missing and/or improper torquing of clutch cover mounting bolts	Consult Eaton's Installation Instructions.
	Incorrect driven assembly installed - it is too thick	Install the correct disc.

### Noisy/Rattling

Complaint	Possible Cause	Corrective Action
Noise/Rattling	Throw out bearing is worn/seized	Replace the throw out bearing. If reusing the clutch, ensure that the release levers are not damaged (see Figure 38).
	Incorrect driven disc has been installed	Install correct driven disc assembly.

## Clutch Glossary

### 1401

14" single plate clutch (pull-type).

### 1402

14" two plate clutch (pull-type).

### Adjusting Ring

Threaded lever support ring inside clutch. Needs to be rotated toward FW to keep proper angle relationship between pressure springs and levers. Turned by mechanic via Kwik-Adjust (SAS and EPP), or lock strap (AS).

### Angle-Ring (A/R)

Medium-Duty, push to release, uses Belleville spring, no internal adjustment, 310mm, 330mm (Ford), 350mm.

### Angle Spring (AS)

Predecessor to EP. No longer in production. Large population in Reman and rebuilt markets.

### Bearing Load

Load applied to release bearing to move it .500" releasing the clutch. Bearing load relates to load at clutch pedal.

### Bearing Travel

With clutch engaged, gap between rear bearing cover and front of clutch brake (or transmission bearing cap if not using clutch brake). This is how far the bearing moves when the pedal is depressed. Adequate bearing travel is required to release clutch completely, and for Solo to adjust Industry standard:  $.530 \pm .030$ " (1/2" - 9/16").

### Clutch Brake (CB)

Brake device that rides on transmission input shaft of unsynchronized transmissions behind clutch release bearing. "Sandwiched" between back cover of clutch bearing and front of transmission bearing cap. Should be used to stop excess disc rotation when shifting into first or reverse. Single Piece - Torque limiting (OE standard), Two Piece - not torque limiting (service replacement).

### Clutch Brake Squeeze

Distance of clutch pedal movement from floor of cab to point at which a 0.010" feeler gage is no longer clamped between back of clutch bearing and front of transmission bearing cap. Target usually around 1".

### Coaxial (CO)

Spring inside of a spring. Many dampers use this design to achieve higher bottoming torque.

### Cover Assembly

see Pressure Plate.

### Damper

(Disc, Driven Disc, DDA, Clutch Plate) Portion of clutch affixed to transmission input shaft. Supports friction facings and torsional damping springs.

### Drive Pins

(Drive Dogs) Used with 14" pot style flywheel and 14" cast clutch. Used to carry torque of intermediate plate.

### Easy-Pedal (EP)

Heavy duty 15.5" cast 2-plate clutch that uses 3 assist springs to reduce release loads. Launched in '90 now superseded to EPP.

### Easy-Pedal Plus (EPP)

Easy-Pedal with added features: 2-piece retainer, Super Seal on adjustment threads, improved Kwik-Adjust, positive pin separator in intermediate plate.

### Engaged

Release bearing is in its rest position - clutch discs clamped up.

# Glossary

---

## **Free Pedal (FP)**

(Free Play, Toe Play) Amount the clutch pedal moves inside the cab before the release yoke contacts the wear pads on the release bearing. Usually 1/8" of free travel gives 1.5" to 2.5" (depends on OEM & Model).

## **Front Intermediate Plate**

Towards the engine.

## **Intermediate Plate**

(Center Plate, Floater Plate) Cast iron plate between front and rear driven discs. 14" MD driven by straps affixed to aluminum spacer ring, 14" cast driven by (6) drive pins mounted in pot flywheel, 15.5" cast driven by (4) integral lugs fitting into cover assembly slots.

## **Kwik-Ajust**

Adjustment mechanism used to adjust non-Solo pull clutches. Small gear when depressed engages adjusting ring allowing it to be turned to maintain proper adjustment.

## **O.E.M.**

Original Equipment - Usually refers to the manufacturer of the vehicle.

## **Positive Separator Pin**

Steel pegs positioned around the outer edge of the Pin intermediate plate to ensure a constant gap on both sides of the plate as the clutch is released.

## **Pot Flywheel (Pot FW)**

Flywheel used only with 14" cast clutches - shaped like a cast iron pot. Front disc, intermediate plate, and rear disc contained inside flywheel

## **Pressure Plate (PP)**

(Clutch Cover, Flywheel Ring, Flywheel Bracket): 1. The actual cast iron plate that squeezes driven disc(s). 2. The assembly that contains the pressure plate, springs, release bearing.

## **Pull**

When clutch pedal in cab is depressed, release bearing (throw-out bearing) is pulled away from the engine to release the clutch.

## **Push**

When clutch pedal in cab is depressed, throw-out bearing (release bearing) is pushed toward the engine to release the clutch.

## **Rear**

Towards the transmission.

## **Solo™**

Eaton Fuller's adjustment-free clutch.

## **Stamped Angle Spring (SAS)**

14" Medium-Duty pull release clutch. Name comes from stamped steel cover. Both single plate and two plate versions. Usually refers to adjustable type (Kwik-adjust).

## **Super-Duty**

14" cast EPP with thicker than original intermediate plate to achieve 1400 Lb-ft. Also requires anti-rattle springs. Used with pot flywheel.

## **Throw-out Bearing**

Also known as release bearing in reference to pull style clutches. Refers to bearing housing and bearing which is pulled to release the clutch.



Copyright Eaton Corporation, 2012. Eaton hereby grant their customers, vendors, or distributors permission to freely copy, reproduce and/or distribute this document in printed format. It may be copied only in its entirety without any changes or modifications. THIS INFORMATION IS NOT INTENDED FOR SALE OR RESALE, AND THIS NOTICE MUST REMAIN ON ALL COPIES.

**Note:** Features and specifications listed in this document are subject to change without notice and represent the maximum capabilities of the software and products with all options installed. Although every attempt has been made to ensure the accuracy of information contained within, Eaton makes no representation about the completeness, correctness or accuracy and assumes no responsibility for any errors or omissions. Features and functionality may vary depending on selected options.

**For spec'ing or service assistance, call 1-800-826-HELP (4357) or visit [www.eaton.com/roadranger](http://www.eaton.com/roadranger). In Mexico, call 001-800-826-4357.**

Roadranger: Eaton and trusted partners providing the best products and services in the industry, ensuring more time on the road.

**Eaton Corporation**

Vehicle Group  
P.O. Box 4013  
Kalamazoo, MI 49003 USA  
800-826-HELP (4357)  
[www.eaton.com/roadranger](http://www.eaton.com/roadranger)

Printed in USA